

Atraumatische Gefäßklemmen

Atraumatic vascular clamps

Atraumatiques Pinces vasculaires

FH



Halstead-Mosquito

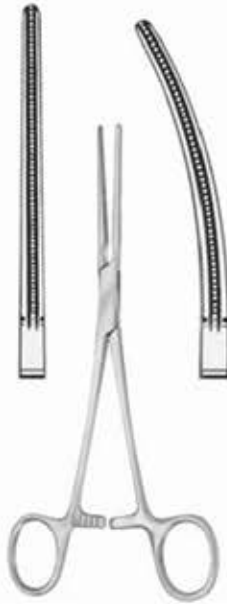

Pean



Rankin

cm	inch	str	cvd	str	cvd	str	cvd
12.0	4.8	FH-0800-12	FH-0801-12	—	—	—	—
14.0	5.6	—	—	FH-0802-14	FH-0803-14	—	—
15.0	6.0	FH-0800-15	FH-0801-15	—	—	—	—
16.0	6.4	—	—	FH-0802-16	FH-0803-16	FH-0804-16	FH-0805-16
18.0	7.0	—	—	FH-0802-18	FH-0803-18	—	—
20.0	8.0	—	—	FH-0802-20	FH-0803-20	—	—

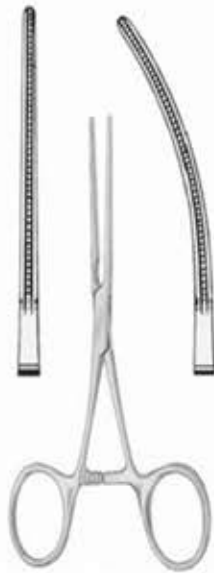

Debaquey

str 12cm/4.8" cvd
FH-1002-12 FH-1003-12



Debaquey

12cm/4.8"
FH-1101-12



Debaquey

12cm/4.8"
FH-1103-12



Debaquey

12cm/4.8"
FH-1201-12

Vena Cava Clamp



Debaky-Beck

Multi-Purpose Clamps



20.5cm/8.2"
FH-2804-20



21cm/8.4"
FH-2804-21



23cm/9"
FH-1001-40

40 mm



23.5cm/9.2"
FH-1001-50

50 mm



Hopt



24.5cm/9.8"
FH-1001-60

60 mm

Bronchus Forceps

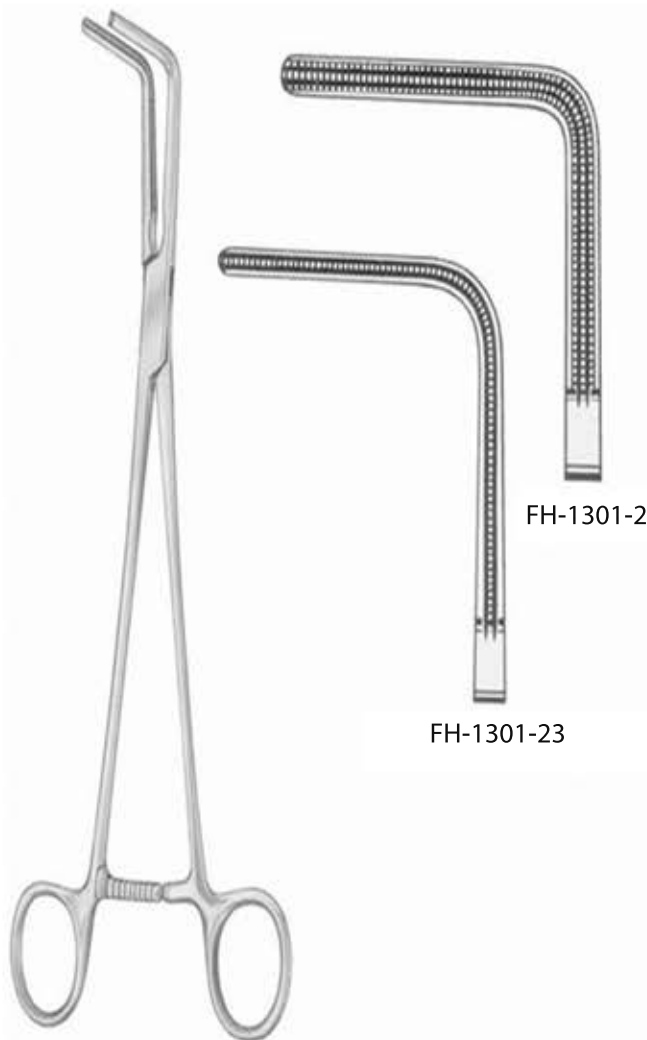

Lees
23cm/9"
FH-1301-23
25cm/10"
FH-1301-25

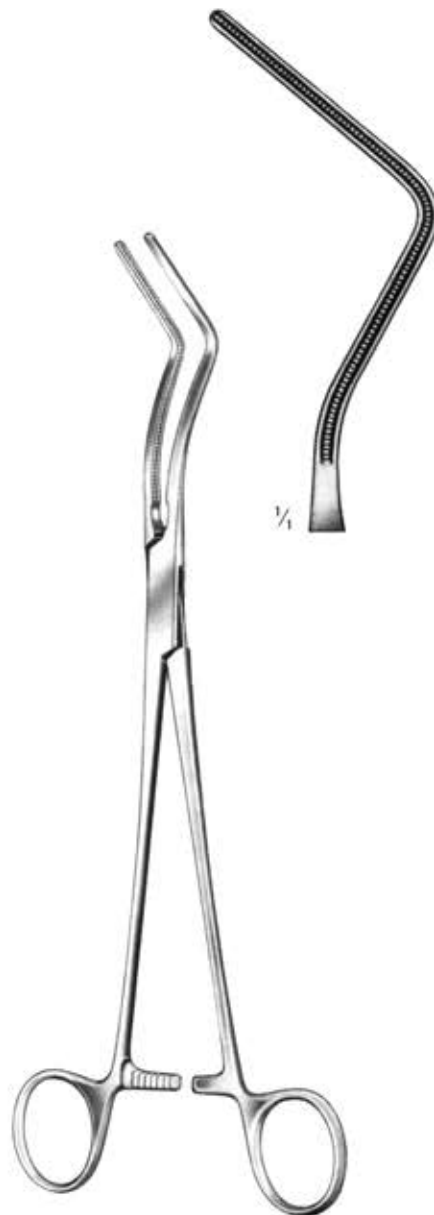

Lees
25cm/10"
FH-1303-25

coarctation clamps

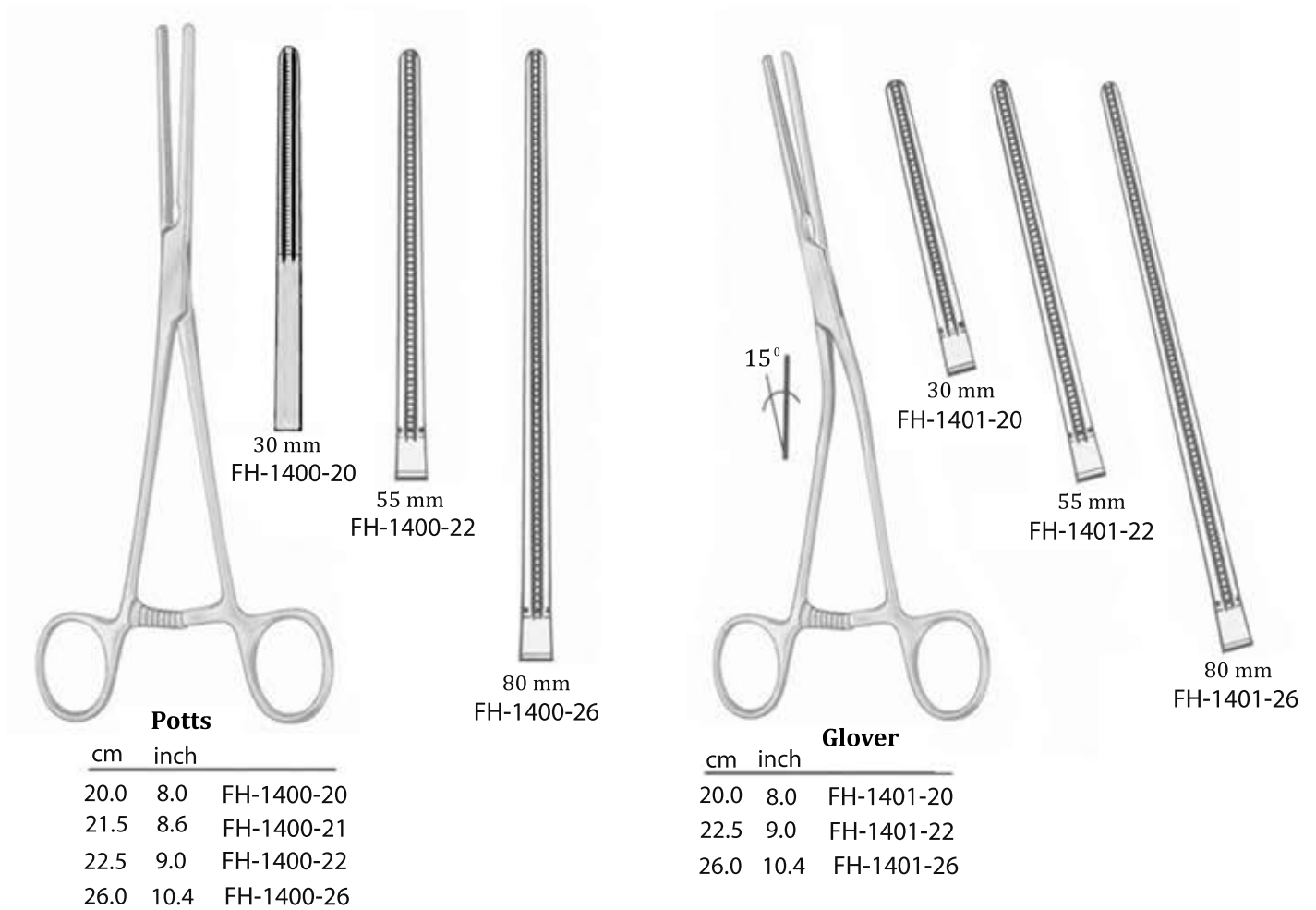

coarctation clamps



Potts



21cm/8.4"
FH-1402-21



22cm/8.8"
FH-1402-22



Potts



21cm/8.4"
FH-1403-21



22cm/8.8"
FH-1403-22



Anastomosis clamps

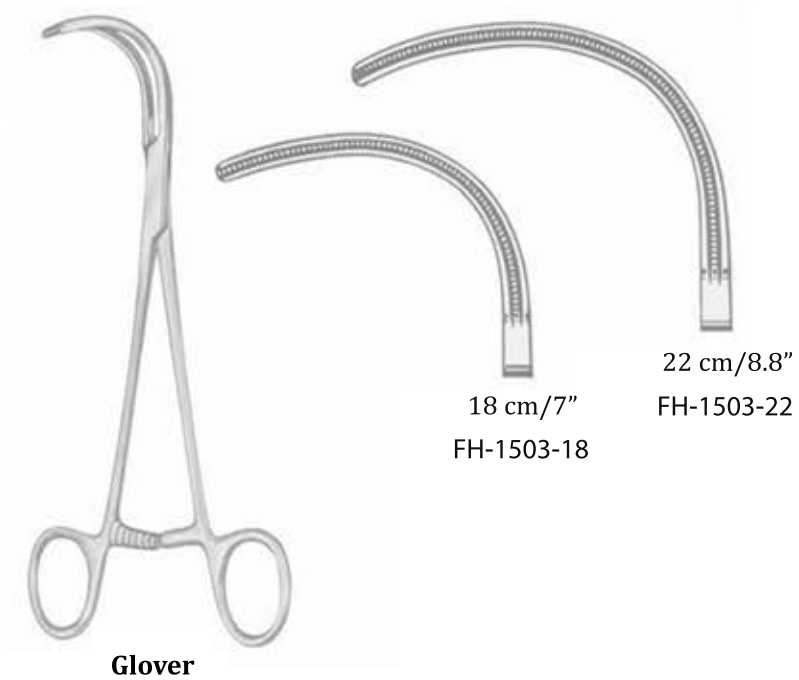

Vascular clamps Spoon shaped

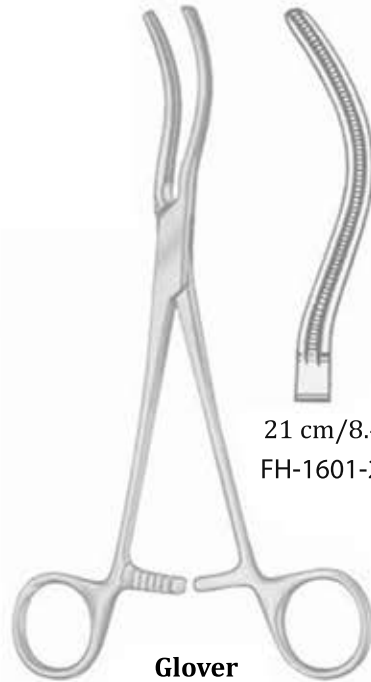

Peripheral Vascular forceps

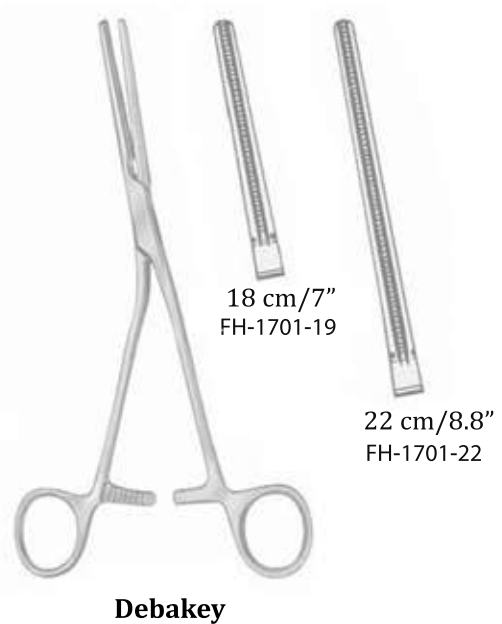

Atraumatic Multi-Purpose Clamps



Dardik

cm	inch	0°	15°	30°	45°	90°
14.0	5.6	—	—	—	—	FH-1702-90
15.0	6.0	FH-1702-00	FH-1702-15	FH-1702-30	FH-1702-45	—

cm	inch	0°	15°	30°	45°	90°
16.0	6.4	—	—	—	—	FH-1704-90
17.0	6.8	FH-1704-00	FH-1704-15	FH-1704-30	FH-1704-45	—

Peripheral Vascular Forceps



Leland-Jones
19 cm/7.6"
FH-1801-19



DeBakey
26cm/10.4"
FH-1801-26

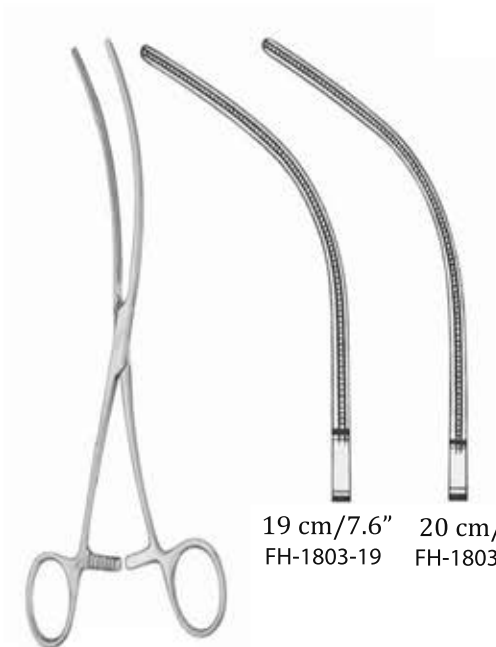

19 cm/7.6" 20 cm/8"
FH-1803-19 FH-1803-20



DeBakey
16 cm/6.4"
FH-1901-16



Bainbridge

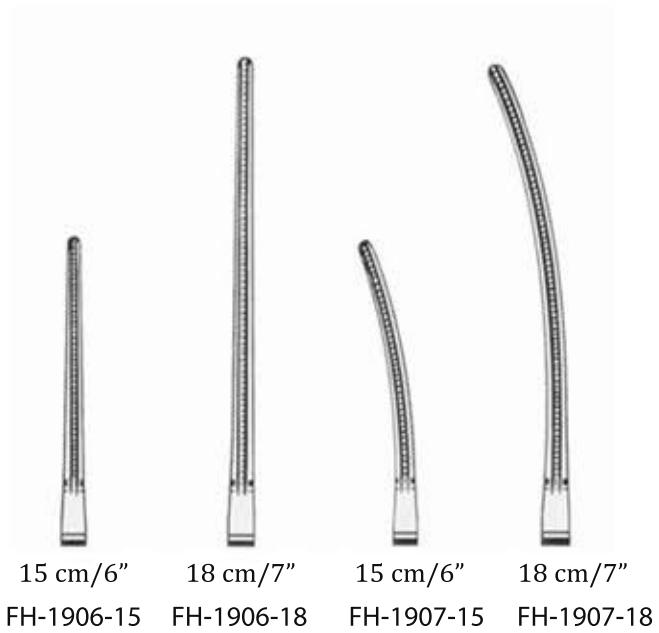

15 cm/6" FH-1906-15 18 cm/7" FH-1906-18 15 cm/6" FH-1907-15 18 cm/7" FH-1907-18

Peripheral Vascular Forceps

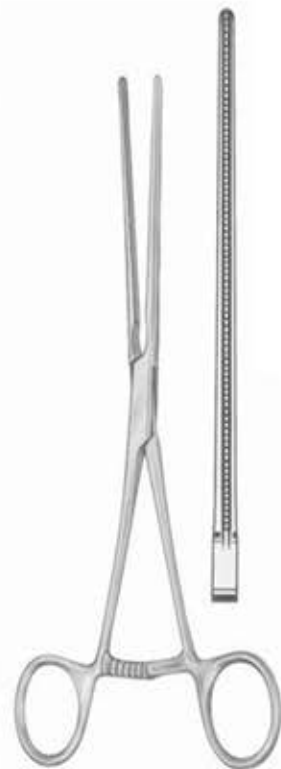

Leland-Jones
19 cm/7.6"
FH-2002-19

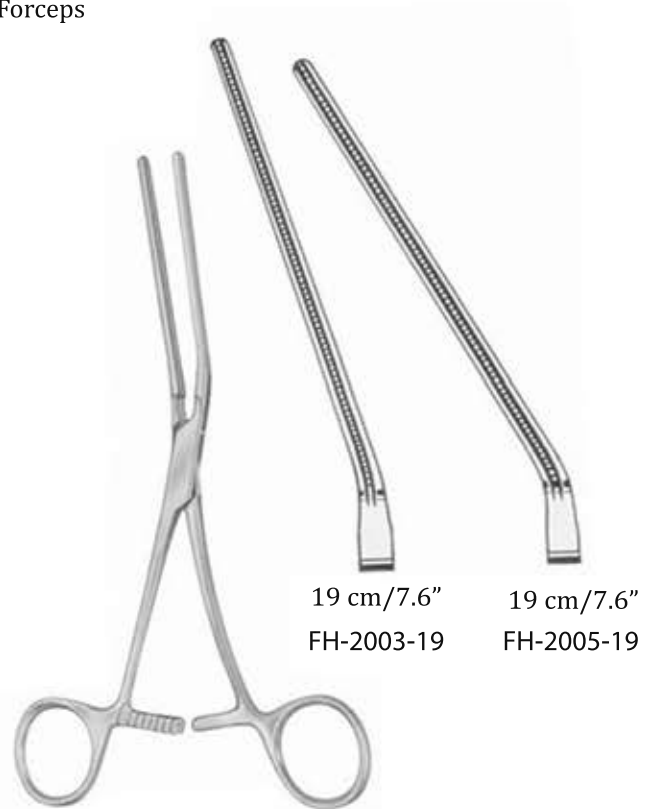

19 cm/7.6" FH-2003-19 19 cm/7.6" FH-2005-19

Aortic anastomosis clamp

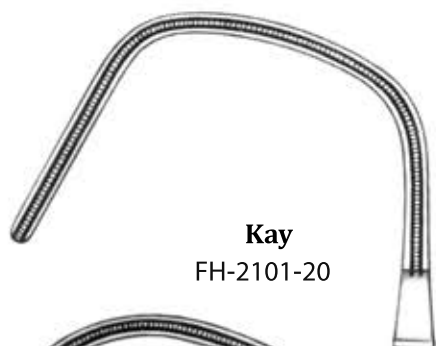

Kay
FH-2101-20



Lambert-Kay
FH-2103-21

Aortic Clamp



Liddle
27cm/10.8"
FH-2009-27

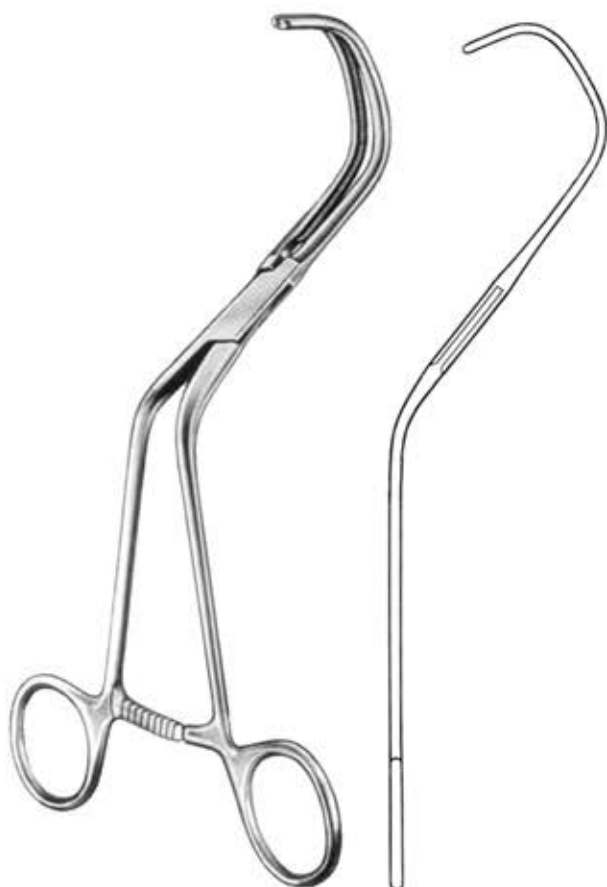

Kay Lambert-Kay
20 cm/8"

Iliac Clamp



DeBakey
20 cm/8"
FH-2105-20



curved to left

Weber
26cm/10.4"
FH-2107-26



curved to right

Weber
26cm/10.4"
FH-2109-26

Aortic-Aneurysm Clamps

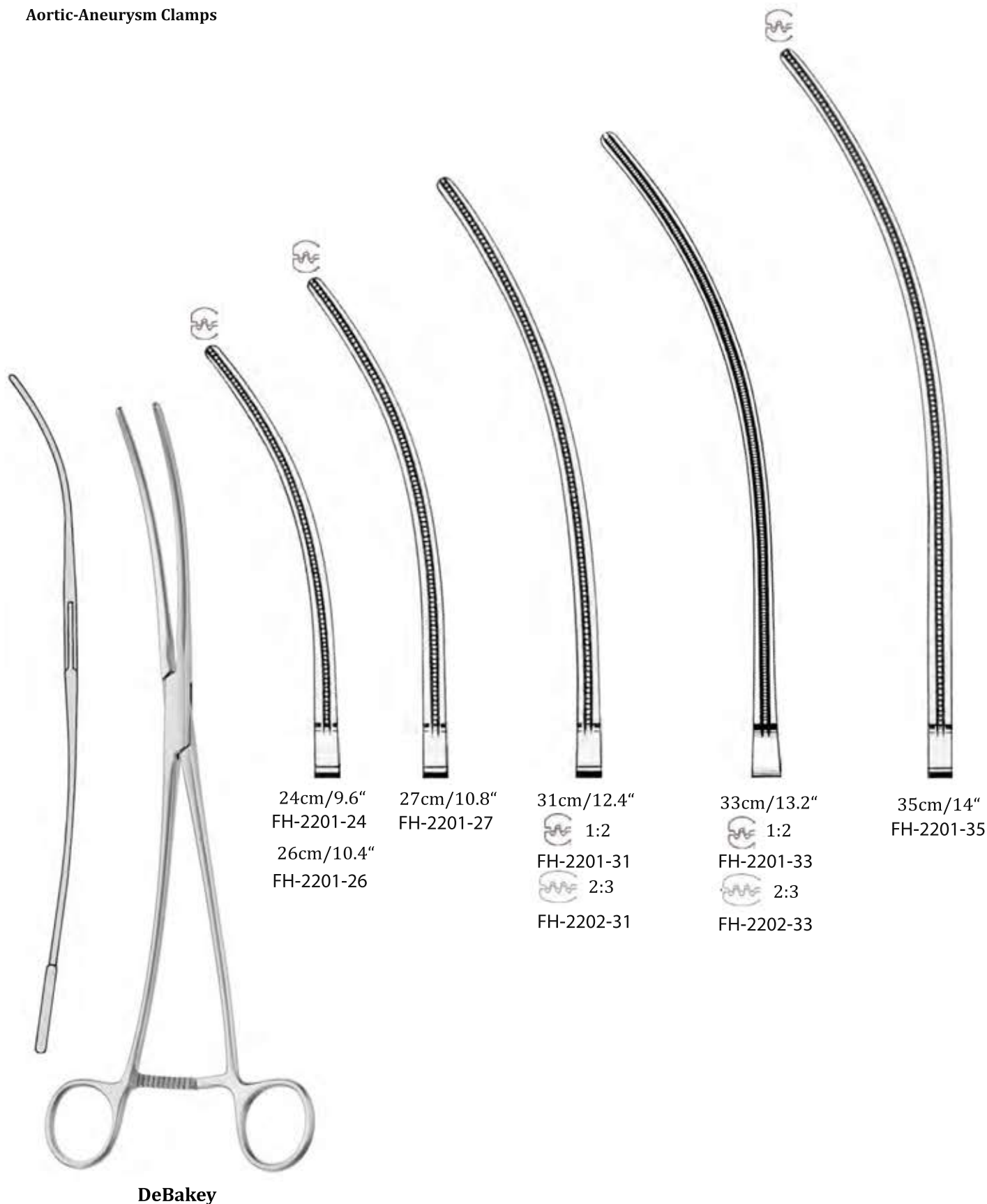

Aortic-Aneurysm Clamps



DeBakey Bahnson

24cm/9.6"	25cm/10"	26cm/10.4"
FH-2203-24	FH-2203-25	FH-2203-26

Aortic-Aneurysm Clamps

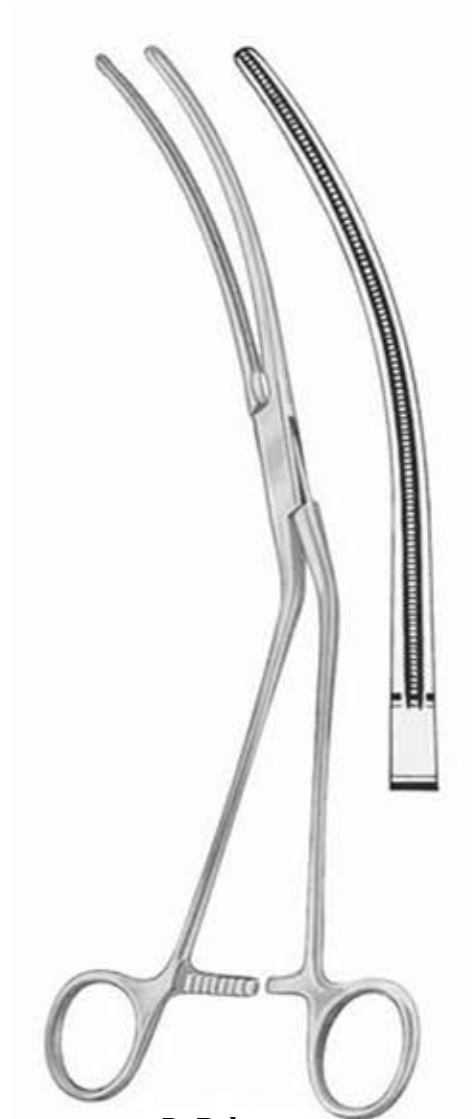

DeBakey
28cm/11"
FH-2205-28



DeBakey
28cm/11"
FH-2207-28

Atraumatic Multi-Purpose Clamps



DeBakey Morris

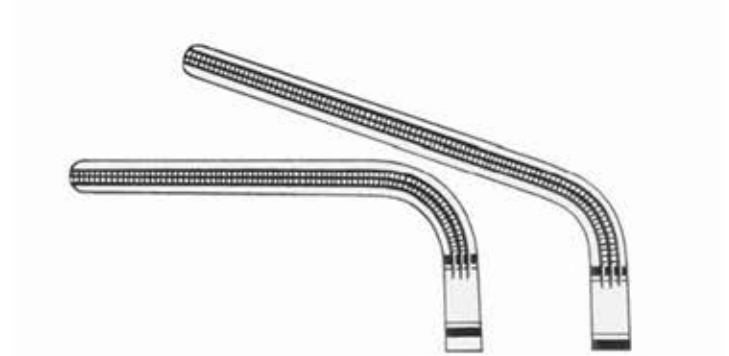

18cm/7" 20cm/8"
FH-2209-18 FH-2209-20



23cm/9" 25cm/10"
FH-2209-23 FH-2209-25

Atraumatic Multi-Purpose Clamps

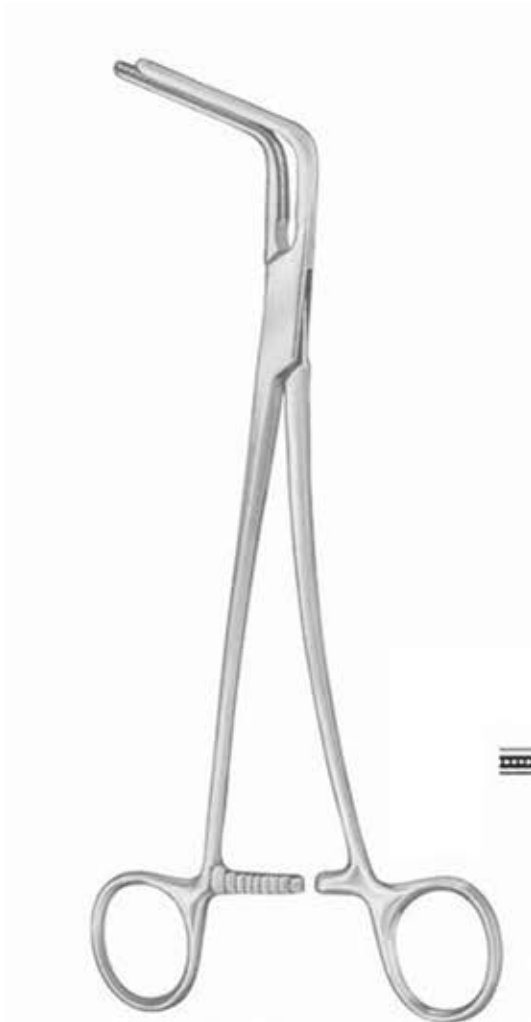

DeBakey

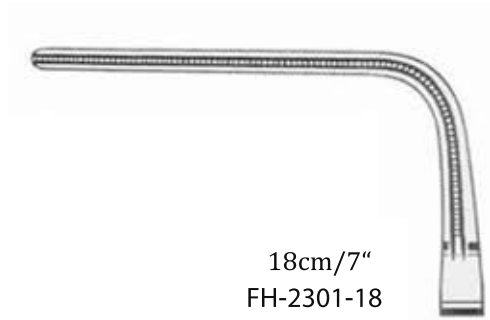

18cm/7"
FH-2301-18

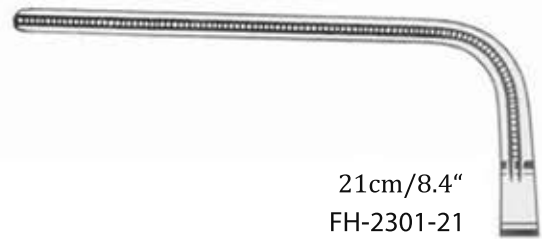

21cm/8.4"
FH-2301-21

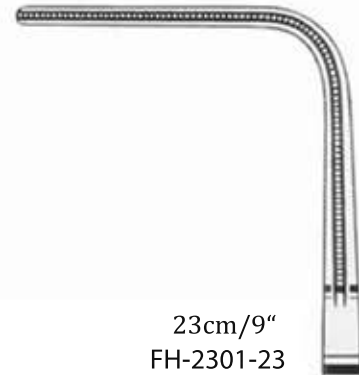

23cm/9"
FH-2301-23



27cm/10.4"
FH-2301-27

Aortic-Aneurysm Clamps



Atraumatic Multi-Purpose Clamps

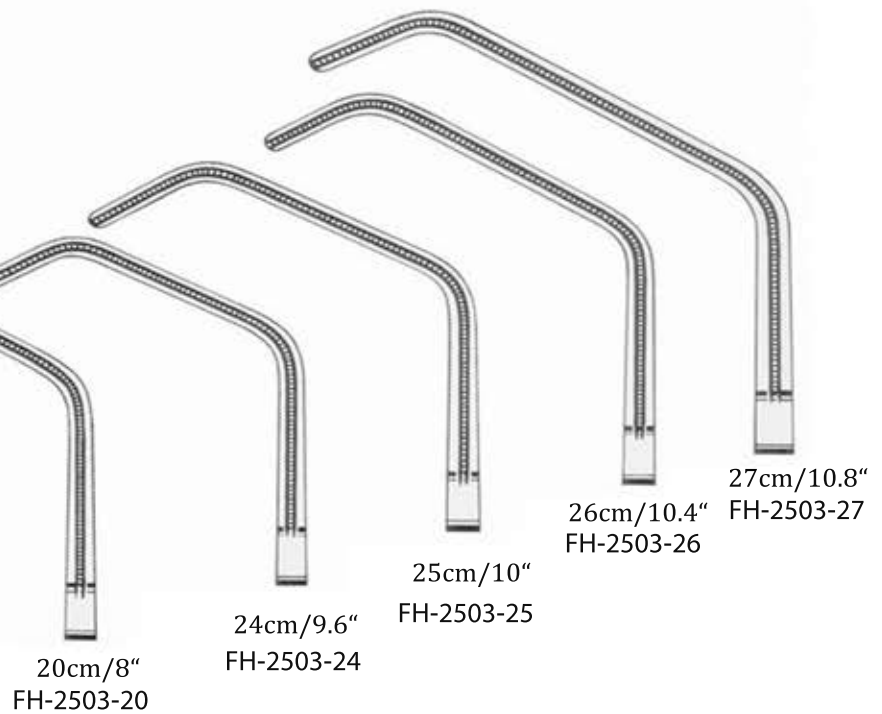
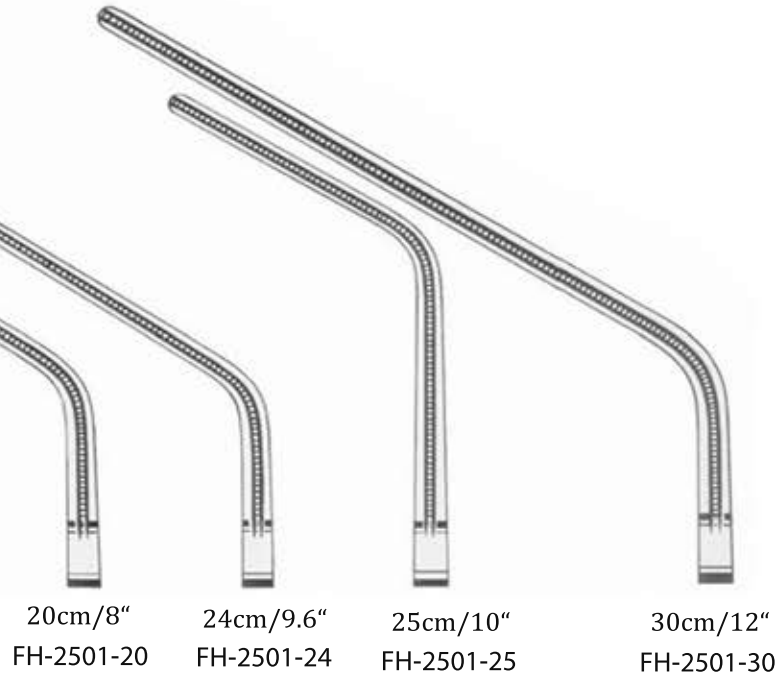

Applying Forceps for Clips

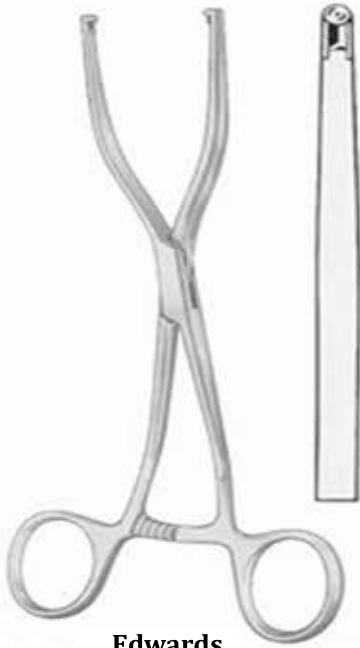

Edwards
FH-2508-00



Clips

mm	Edwards
6	FH-2508-06
12	FH-2508-12



Wylie

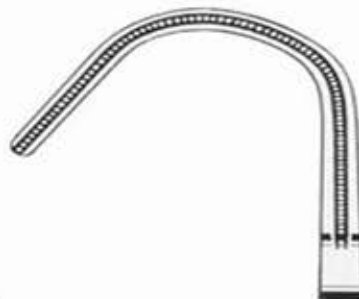

Fig.1
21cm/8.4"
FH-2509-01

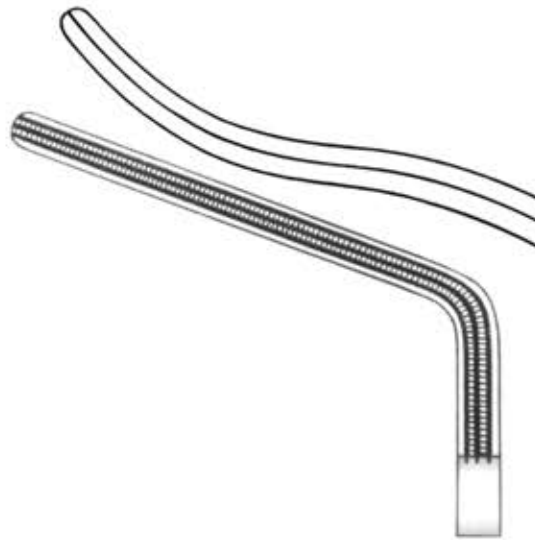

Fig. 2
22cm/8.8"
FH-2509-02

Bronchus Clamps



DeBakey



27cm/10.8"
FH-2407-27



DeBakey Satinsky

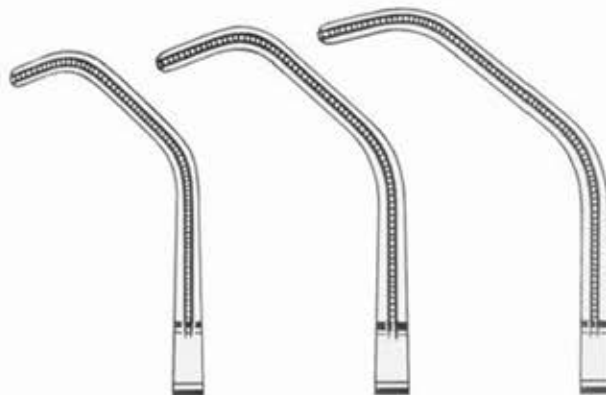

Fig. 1
23cm/9"
FH-2601-23

Fig. 2
24cm/9.6"
FH-2601-24

Fig. 3
25cm/10"
FH-2601-25

Auricle Clamp



Harken

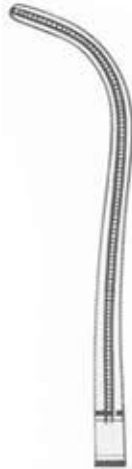

Fig. 1
25cm/10"
FH-2603-25



Fig. 2
24cm/9.6"
FH-2605-24

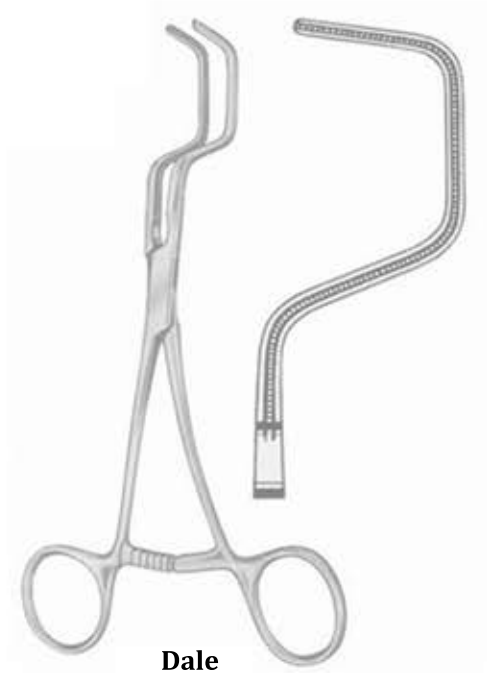

Fig. 3
24cm/9.6"
FH-2607-24

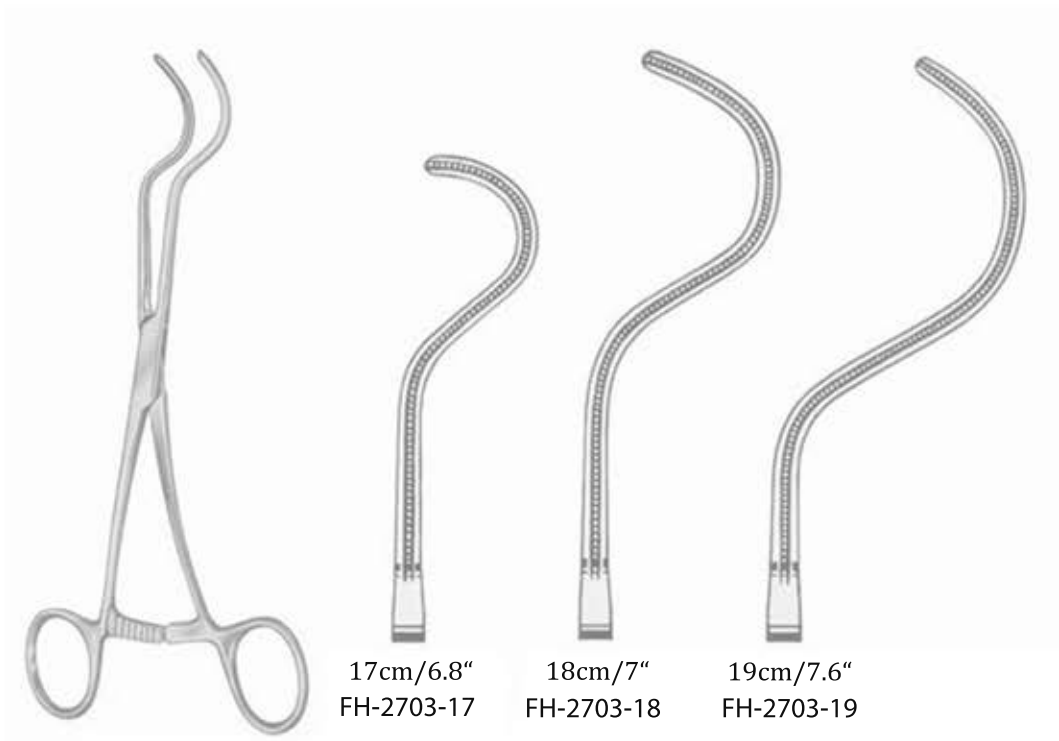

Fig. 4
24cm/9.6"
FH-2609-24

Peripheral Vascular Clamps



Dale
18cm/7"
FH-2701-18



Dale

17cm/6.8"
FH-2703-17

18cm/7"
FH-2703-18

19cm/7.6"
FH-2703-19



DeBakey
17cm/6.8"
FH-2801-17



Beck
17cm/6.8"
FH-2803-17

Dissecting and Ligature Clamps



DeBakey
24cm/9.6"
FH-2805-24



DeBakey
24cm/9.6"
FH-2807-24

Atraumatic Multi-Purpose Clamps

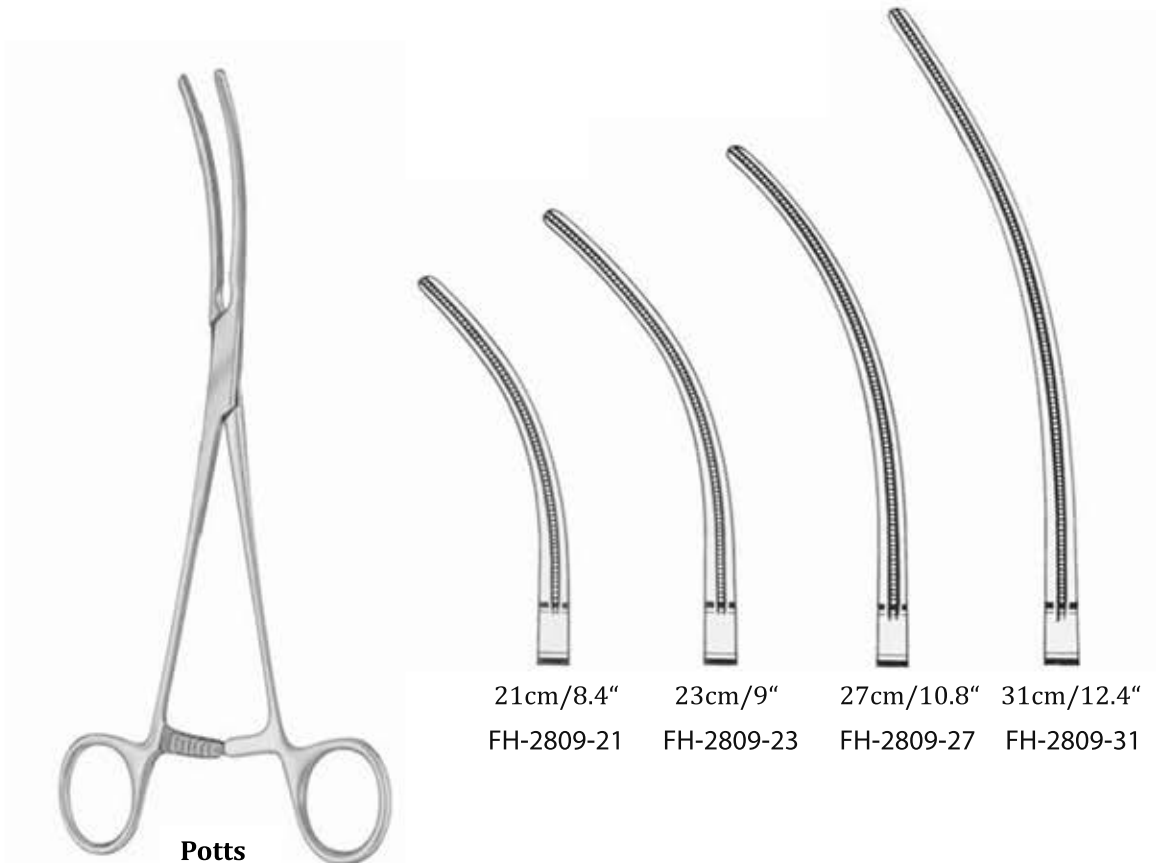
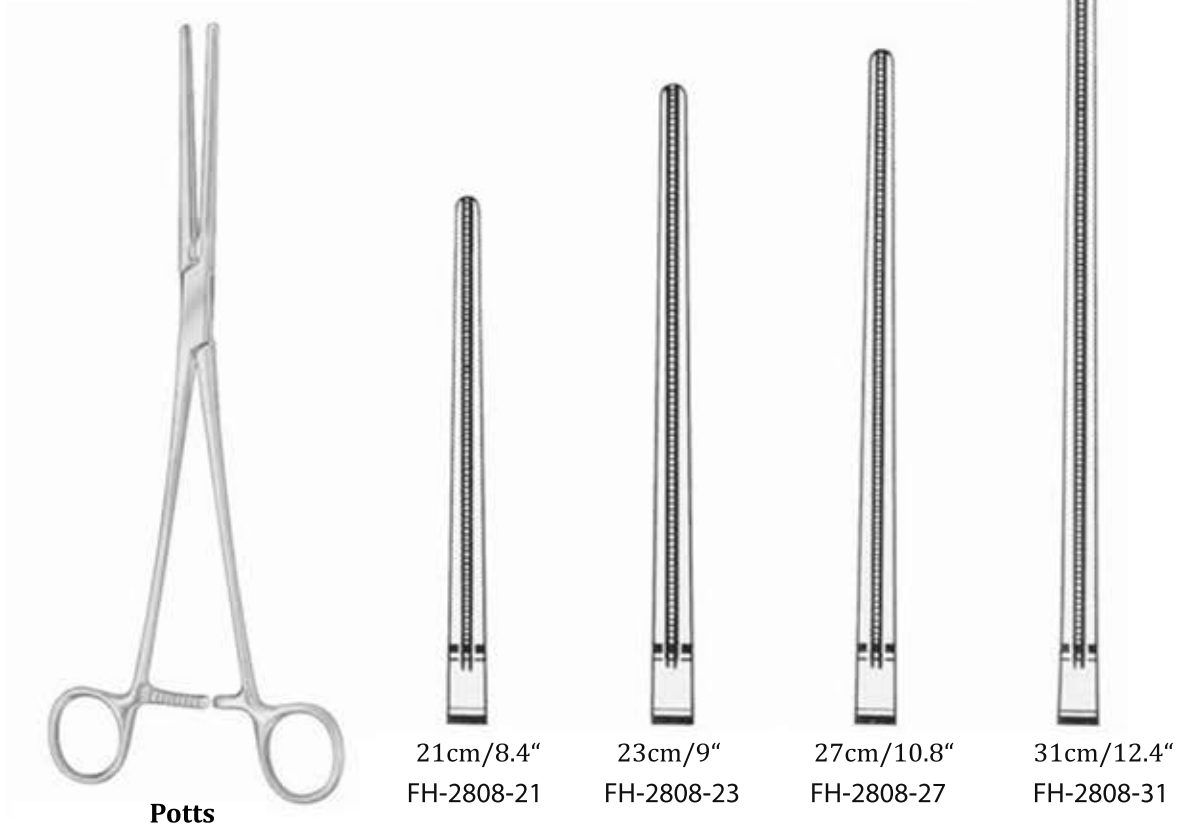

Anastomosis Clamps, Pediatric

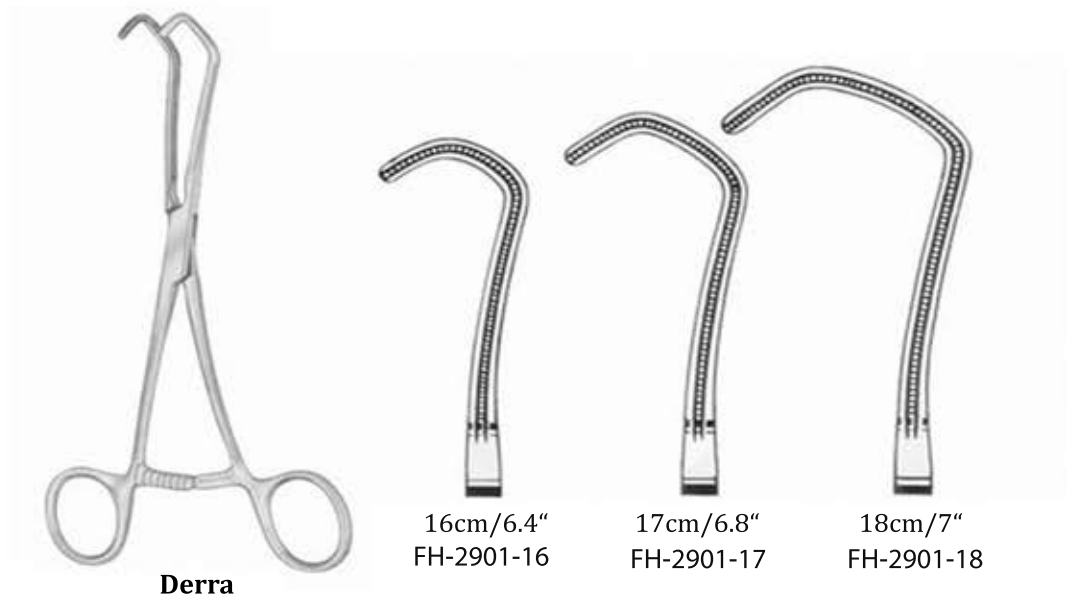

Atraumatic Multi-Purpose Clamps

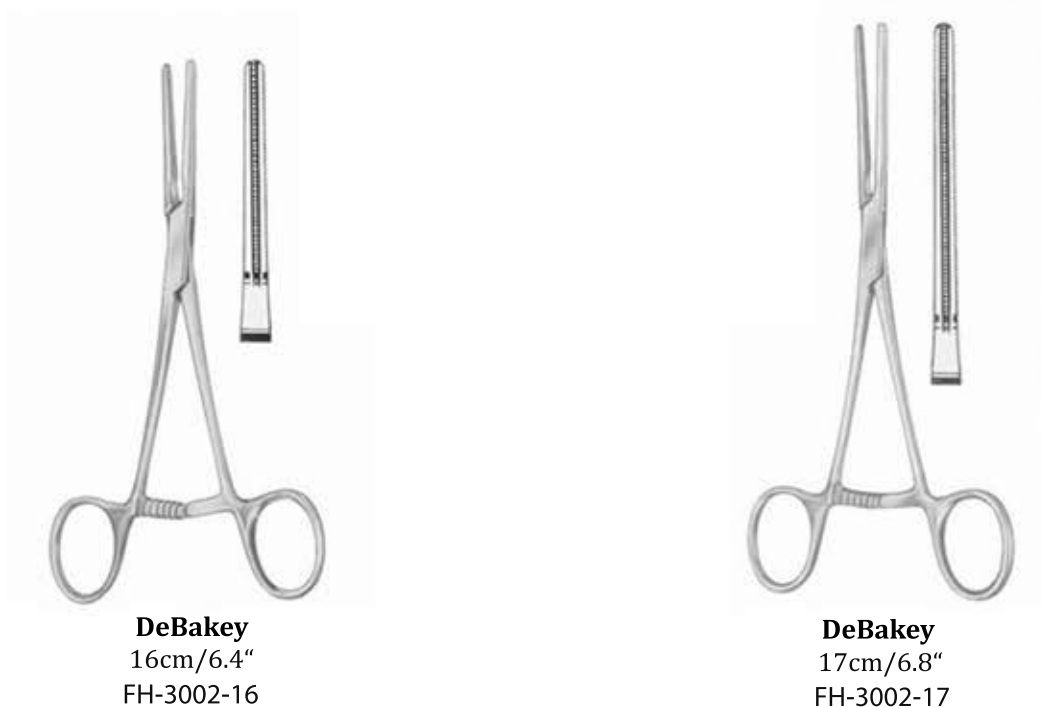

Coarctation Clamps



DeBakey
15cm/6"
FH-3003-15



DeBakey
15cm/6"
FH-3005-15



DeBakey
17cm/6.8"
FH-3007-17



DeBakey

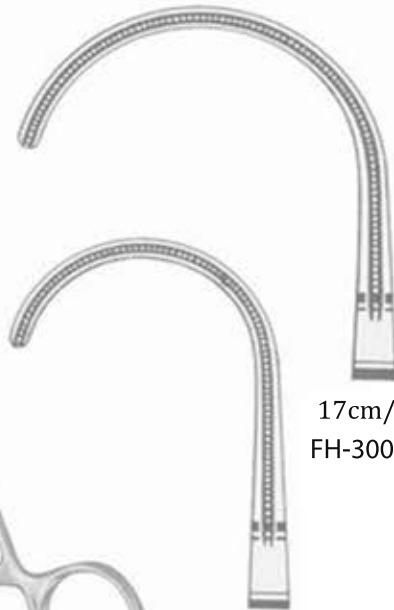

16cm/6.4"
FH-3009-16

17cm/6.8"
FH-3009-17



DeBakey

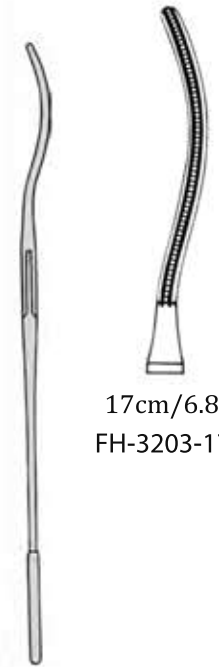

17cm/6.8"
FH-3203-17

Atraumatic Multi-Purpose Clamps

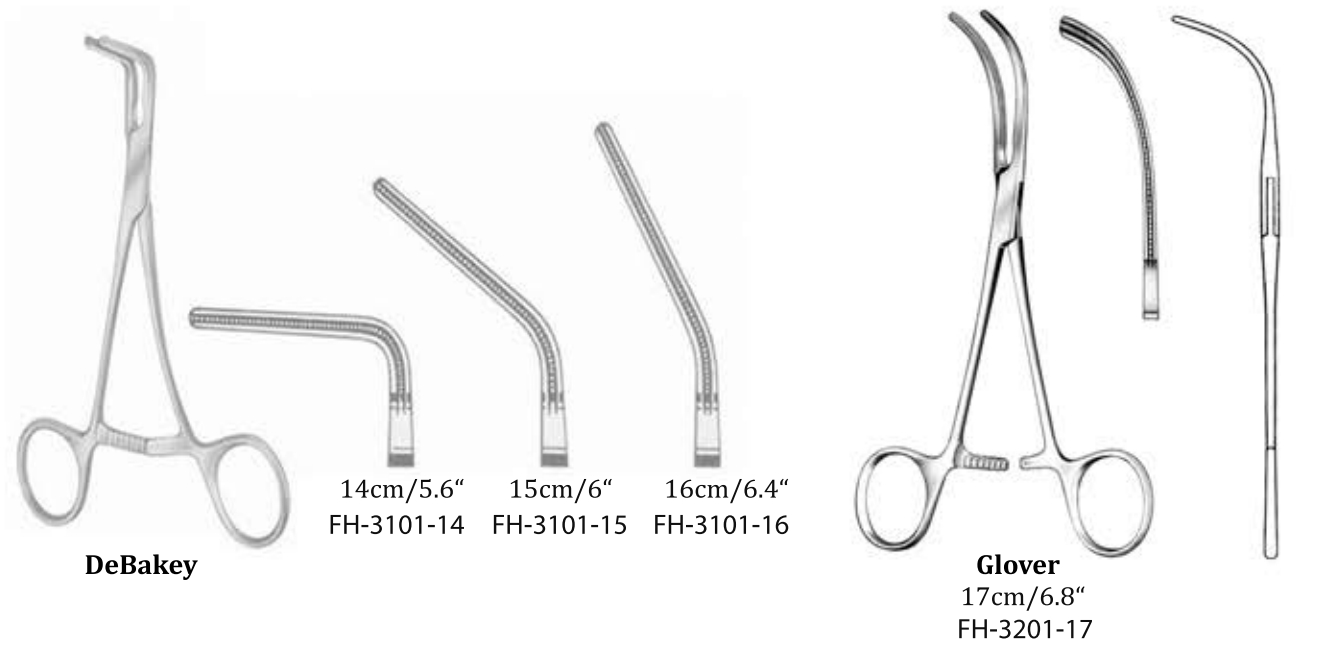

Anastomosis Clamps, Pediatric

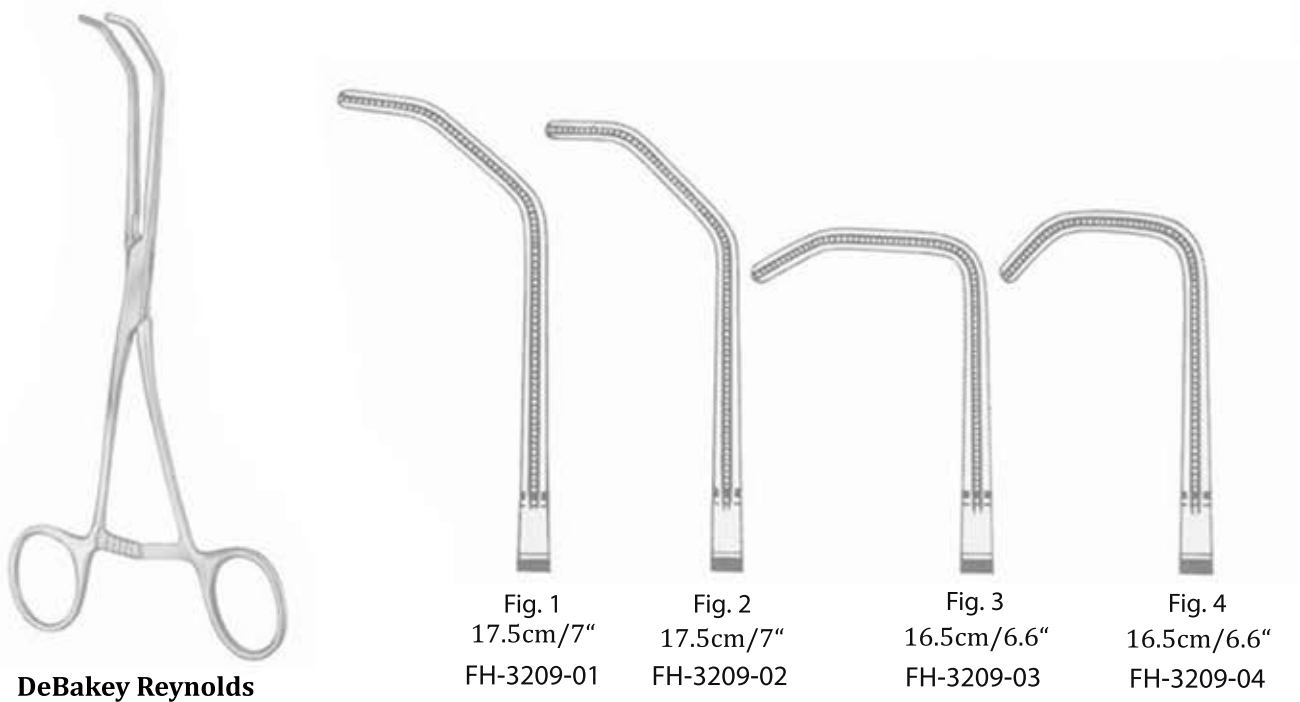

Aortic Clamps



Subramanian
15cm/6"
FH-3301-15

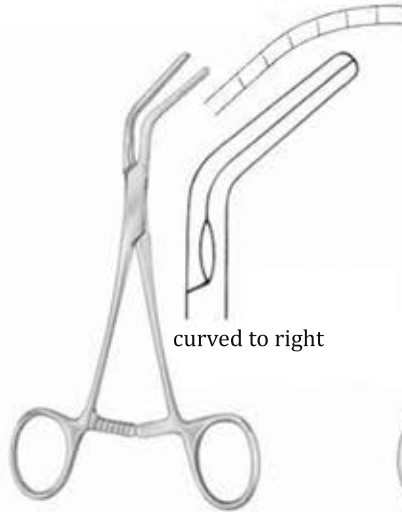

Subramanian
16cm/6.4"
FH-3303-16

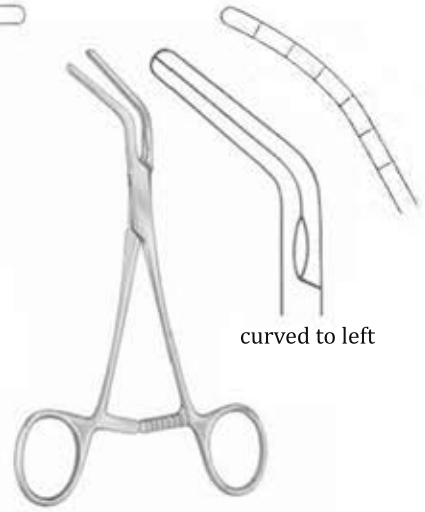

Subramanian
16cm/6.4"
FH-3305-16

Auricle Clamps



Ochsner



Dietrich

Dissecting and Ligature Clamp



DeBakey



19cm/7.6"
FH-3401-19



23cm/9"
FH-3401-23

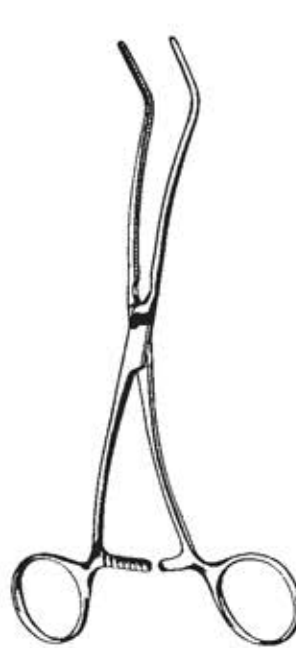

DeBakey



20cm/8"
FH-3401-20

Carotid Shunt Clamp



Javid
18cm/7"
FH-3403-18

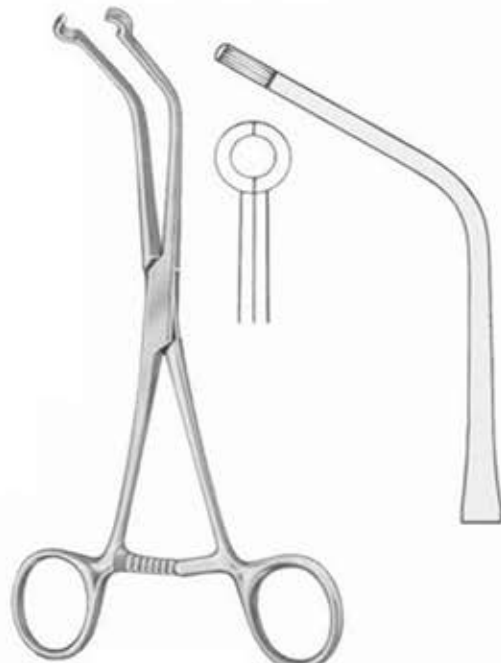

Javid
19cm/7.6"
FH-3403-19

Peripheral Vascular Clamps



Martin - Wylie

16cm/6.4"
FH-3404-16

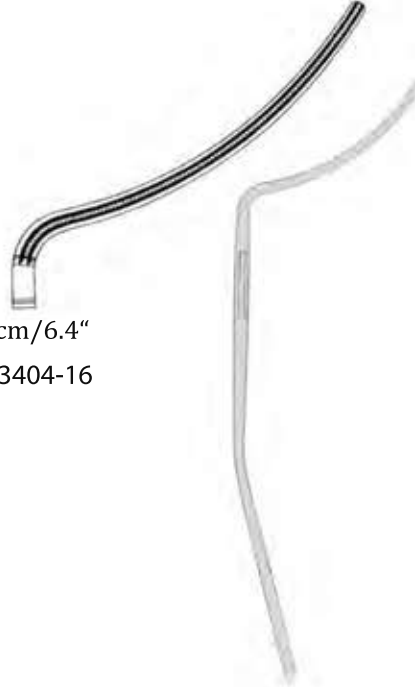

17cm/6.8"
FH-3404-17



18cm/7"
FH-3404-18

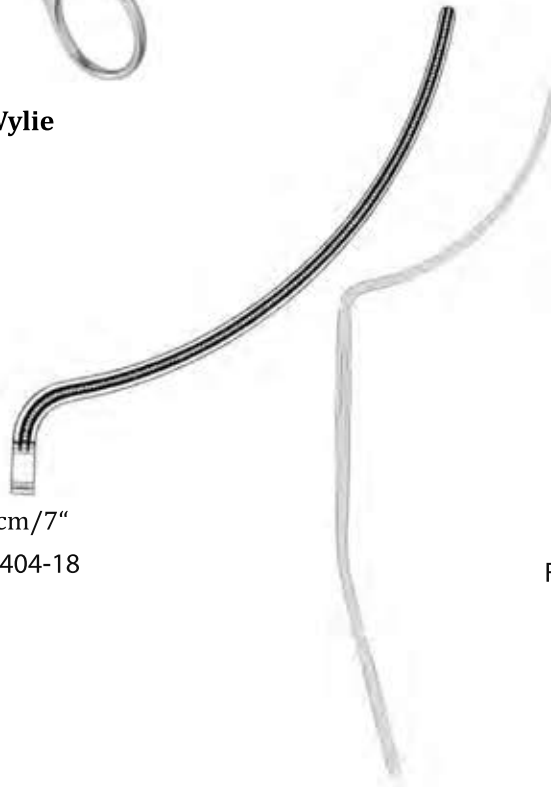

20cm/8"
FH-3404-20

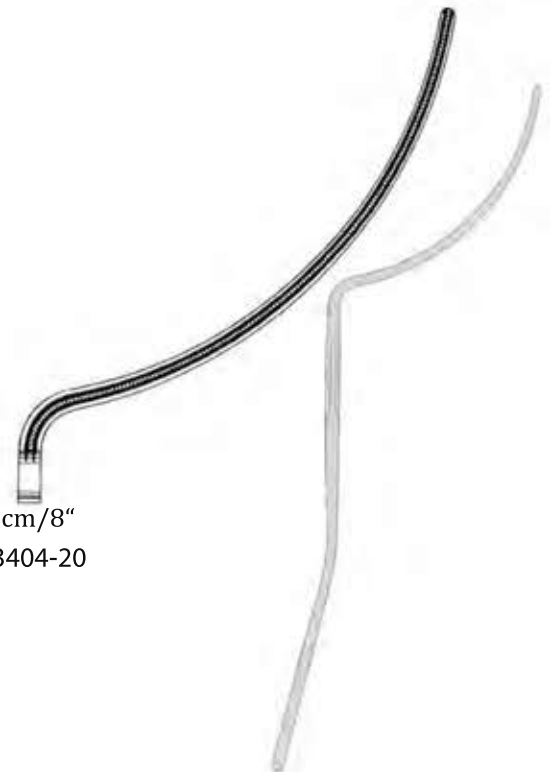

Profunda Clamps

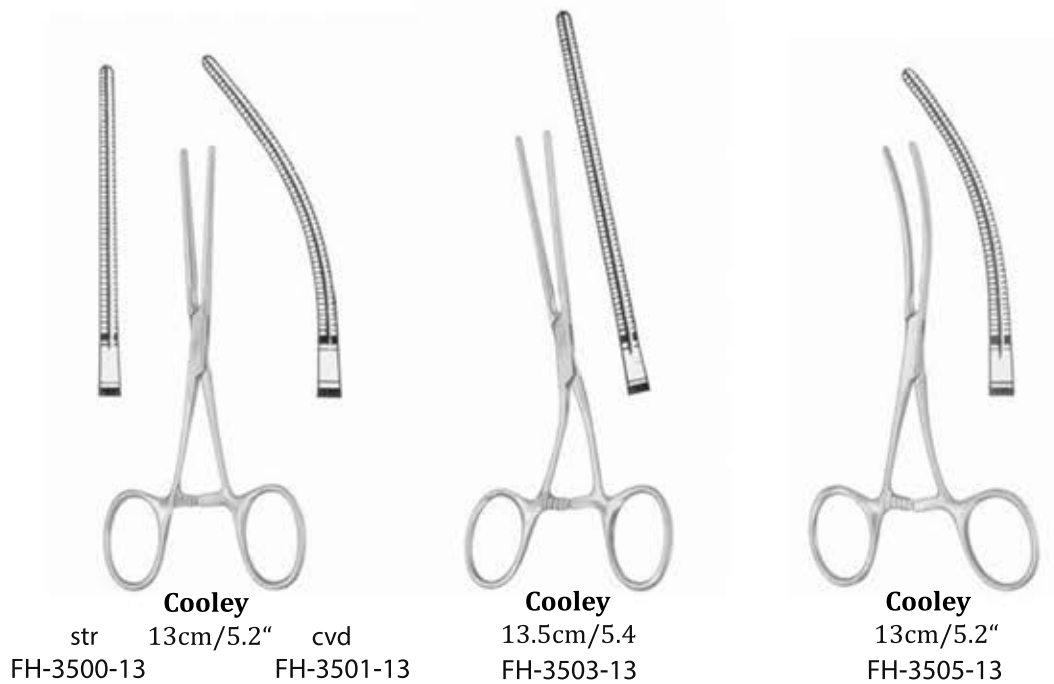
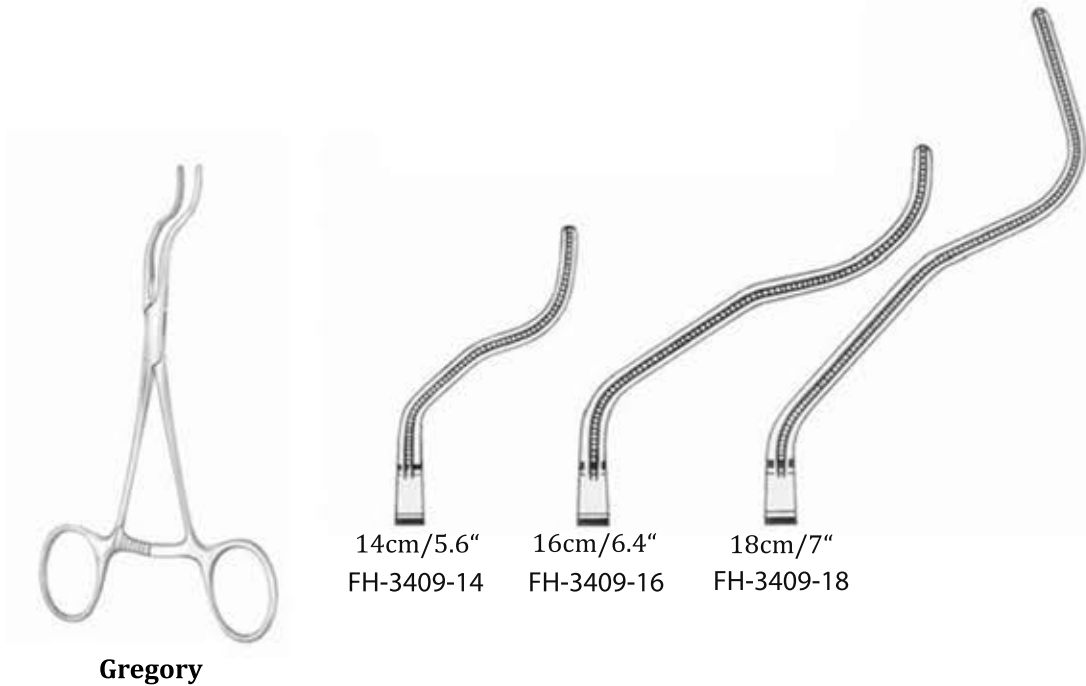

Dissecting and ligature Clamps



DeBakey - Rumel
25cm/10"



80 mm
FH-3405-01



80 mm
FH-3405-02



70 mm



DeBakey - Mc Quigg - Mixer
21cm/8.4"
FH-3405-21



80 mm

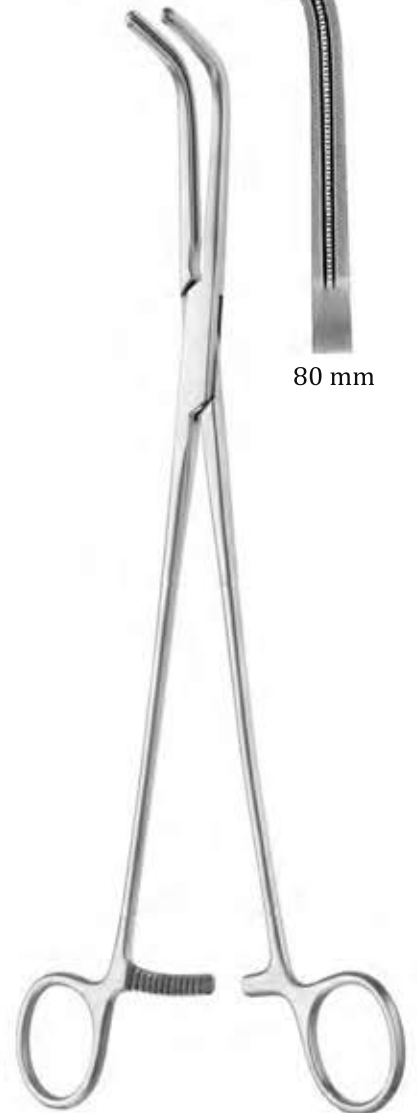

DeBakey - Mixer
28.5cm/11.2"
FH-3405-28



Cooley
12.5cm/5"
FH-3507-12



Cooley
10.5cm/4.2"
FH-3509-10



Cooley
12 cm/4.8"
FH-3601-12

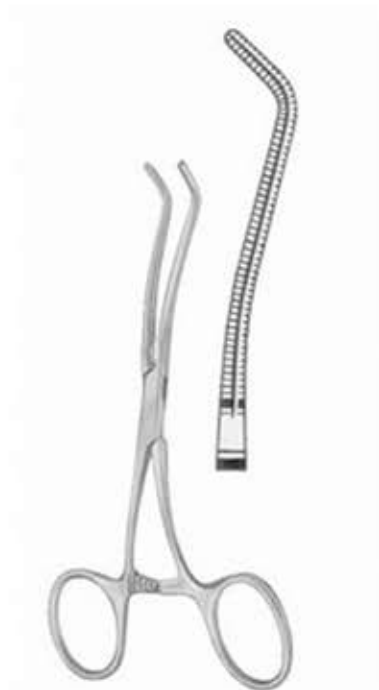

Cooley
13.5cm/5.4"
FH-3603-13

Catheter Clamps



Cooley

Fr./Char

24	FH-3701-24
26	FH-3701-26
28	FH-3701-28
30	FH-3703-30
32	FH-3703-32
36	FH-3703-36

Neonatal and Pediatric Clamps



Cooley

cm	inch	str	ang
14.0	5.6	FH-3706-14	FH-3707-14
16.0	6.4	FH-3706-16	FH-3707-16

Neonatal and Pediatric Clamps



Cooley

14cm/5.6"
FH-3709-14



Cooley

14cm/5.6"
FH-3800-14



Cooley

14cm/5.6"
FH-3801-14

Atraumatic Multi-Purpose Clamps



FH-4100-17

Cooley
17cm/6.8"



FH-4101-17

Cooley
17cm/6.8"



FH-4103-17



FH-4106-17

Liac Clamp



Cooley

21.5cm/8.6" FH-4107-21
25cm/10" FH-4107-25

Anastomosis Clamps



Cooley

17cm/6.8"
FH-4109-17

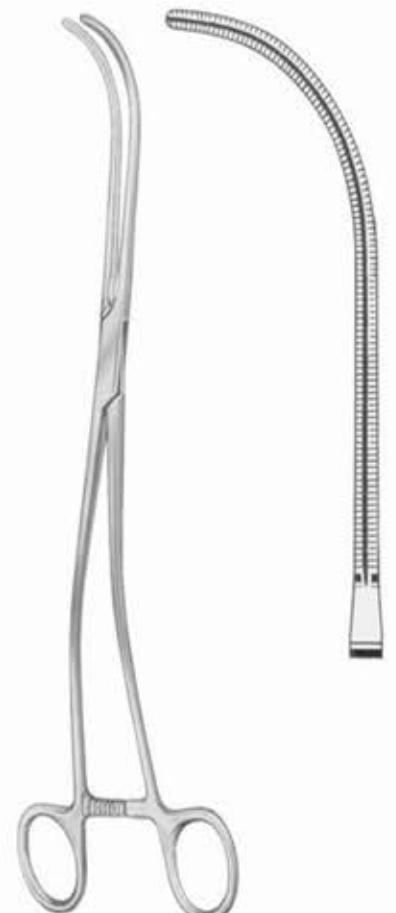

Cooley

27cm/10.8"
FH-4005-27

Anastomosis Clamps



Cooley
str 14cm/5.6" ang
FH-4200-14 FH-4201-14



Cooley
14cm/5.6"
FH-4203-14



Cooley
14cm/5.6"
FH-4205-14



Cooley - Beck



15cm/6"
FH-4206-15



15.5cm/6.2"
FH-4206-16



Cooley
17cm/6.8"



FH-4207-15

FH-4207-16

FH-4207-14

Tangential OcclusionClamps

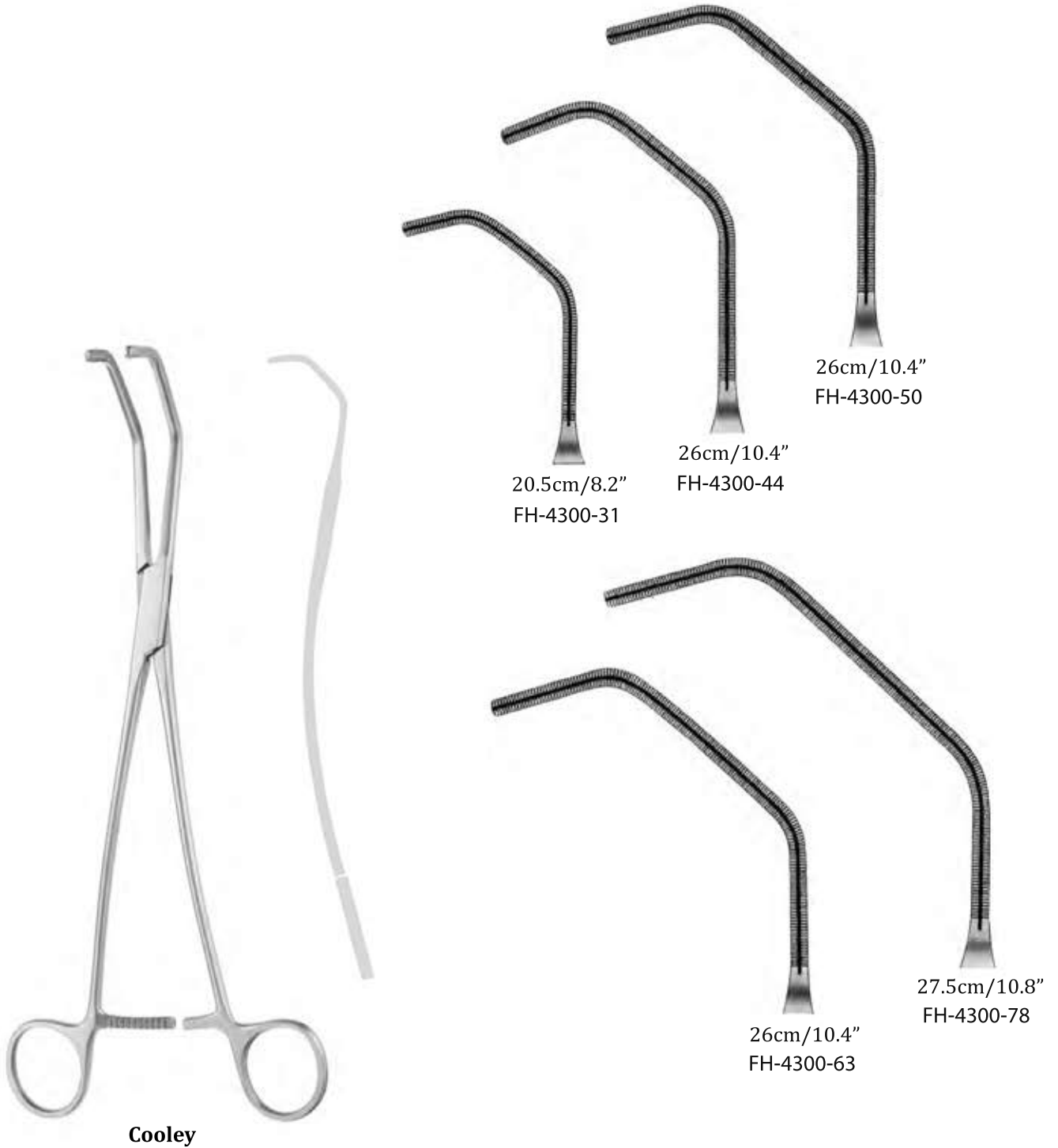

Atraumatic Multi-Purpose Clamps



Anastomosis Clamps

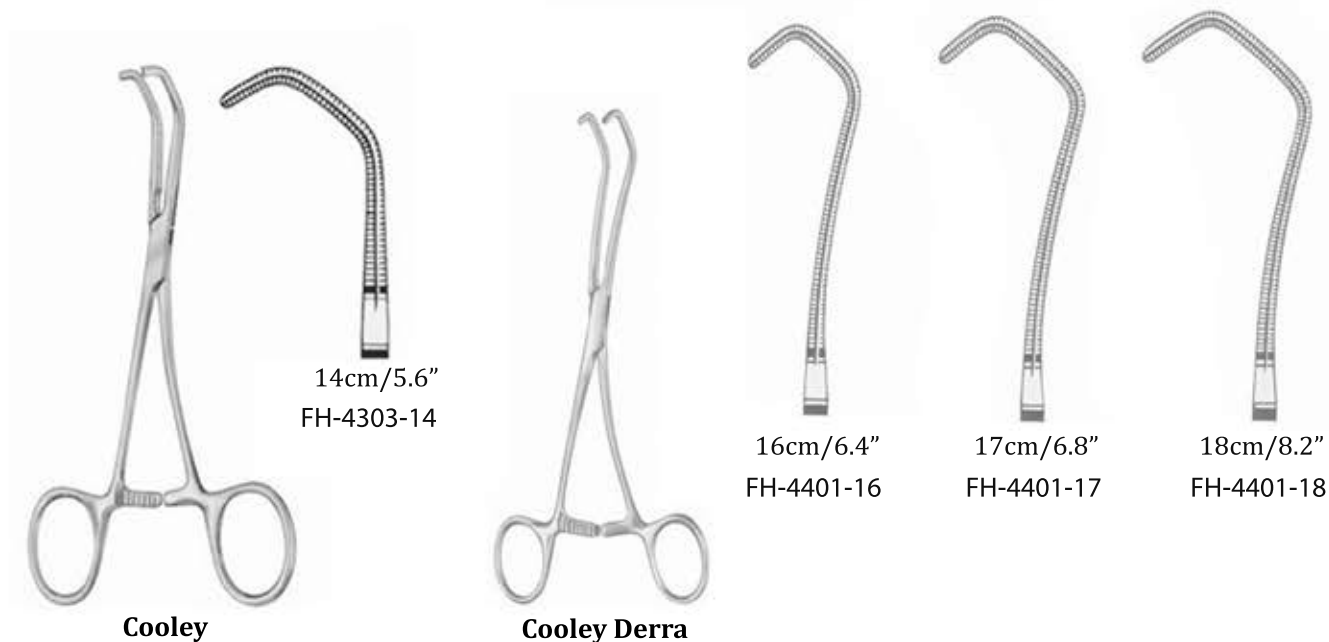

Ligature Carriers



Cooley
17cm/6.8"



31 mm
FH-4407-17



40 mm
FH-4409-17

Anastomosis Clamps



Cooley



16.5cm/6.6"
FH-4500-16

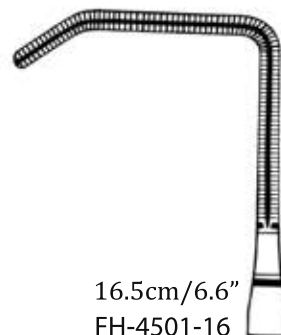

16.5cm/6.6"
FH-4501-16

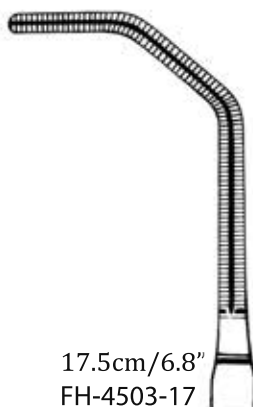

17.5cm/6.8"
FH-4503-17

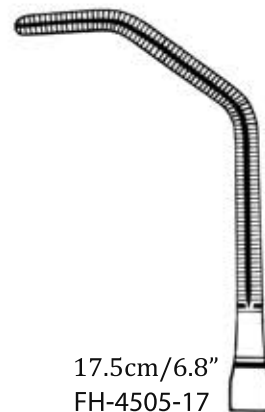

17.5cm/6.8"
FH-4505-17



Cooley
17cm/6.8"
FH-4507-17



Cooley
17cm/6.8"
FH-4601-17



Cooley
18cm/7"
FH-4605-18



Cooley
19cm/7.6"
FH-4605-19



Cooley
26cm/10.4"
FH-4605-26



Cooley
27cm/10.8"
FH-4607-27

Extra delicate pattern



Castaneda
13cm/5.2"
FH-4800-13



Castaneda



12.5cm/5"
FH-4803-13

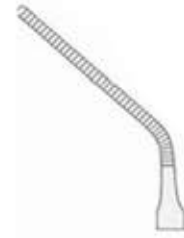

11.5cm/4.6"
FH-4805-13



11.5cm/4.6"
FH-4807-13



11.5cm/4.6"
FH-4809-13



Castaneda



11.5cm/4.6"
FH-4901-12

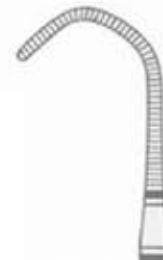

12cm/4.8"
FH-4903-12



12cm/4.8"
FH-4905-12

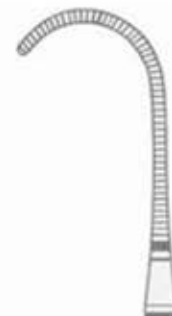

12cm/4.8"
FH-4907-12

Extra delicate pattern



Fig. 1-9

FH-5002-01 - FH-5002-09

straight



Fig. 1-9

FH-5003-01 - FH-5003-09

angled



Fig. 1-9

FH-5005-01 - FH-5005-09

strongly angled



Fig. 1

FH-5002-01

FH-5003-01

FH-5005-01



Fig. 2

FH-5002-02

FH-5003-02

FH-5005-02



Fig. 3

FH-5002-03

FH-5003-03

FH-5005-03



Fig. 4

FH-5002-04

FH-5003-04

FH-5005-04

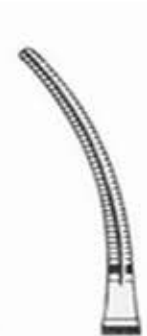

Fig. 5

FH-5002-05

FH-5003-05

FH-5005-05



Fig. 6

FH-5002-06

FH-5003-06

FH-5005-06

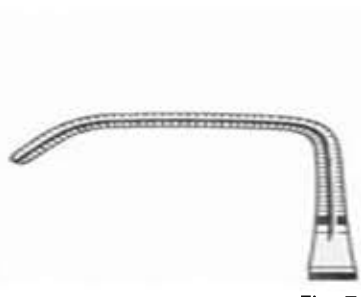

Fig. 7

FH-5002-07

FH-5003-07

FH-5005-07



Fig. 8

FH-5002-08

FH-5003-08

FH-5005-08



Fig. 9

FH-5002-09

FH-5003-09

FH-5005-09

Extra delicate pattern

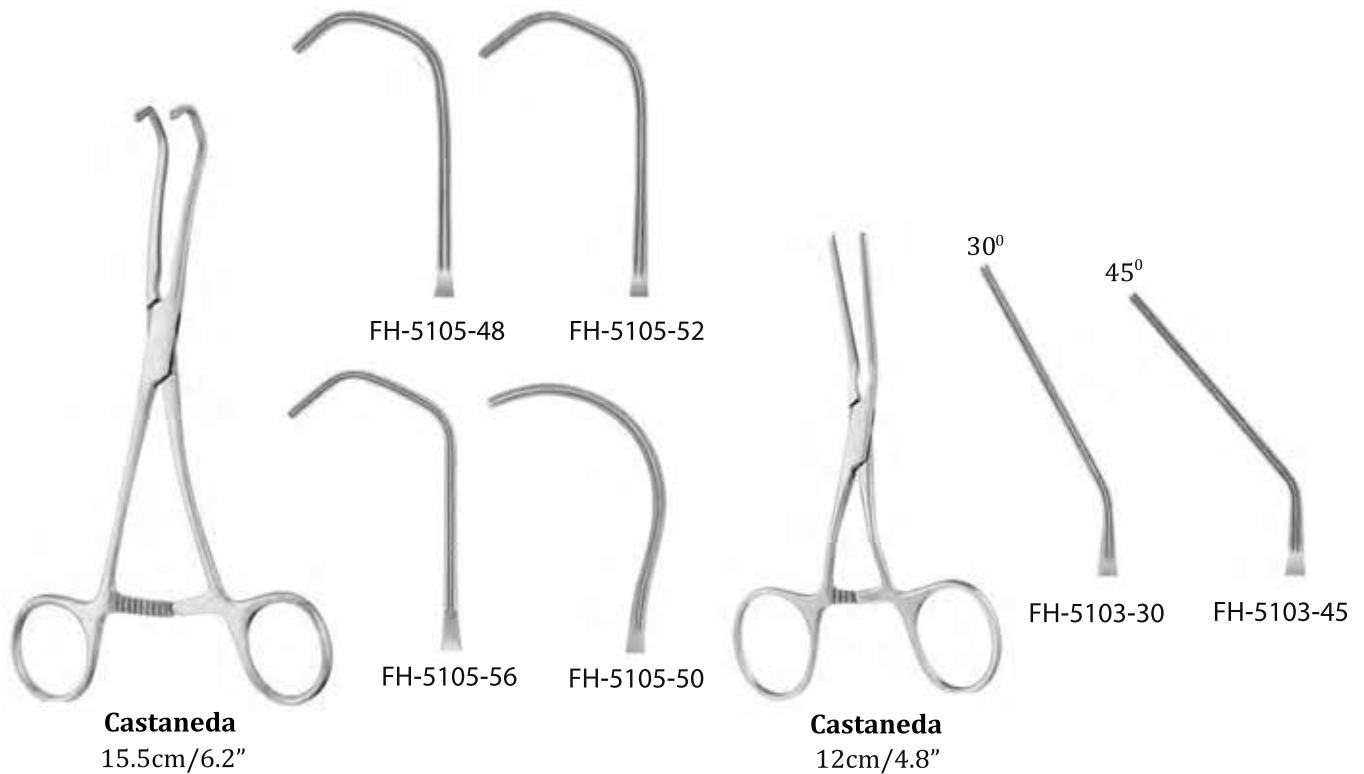
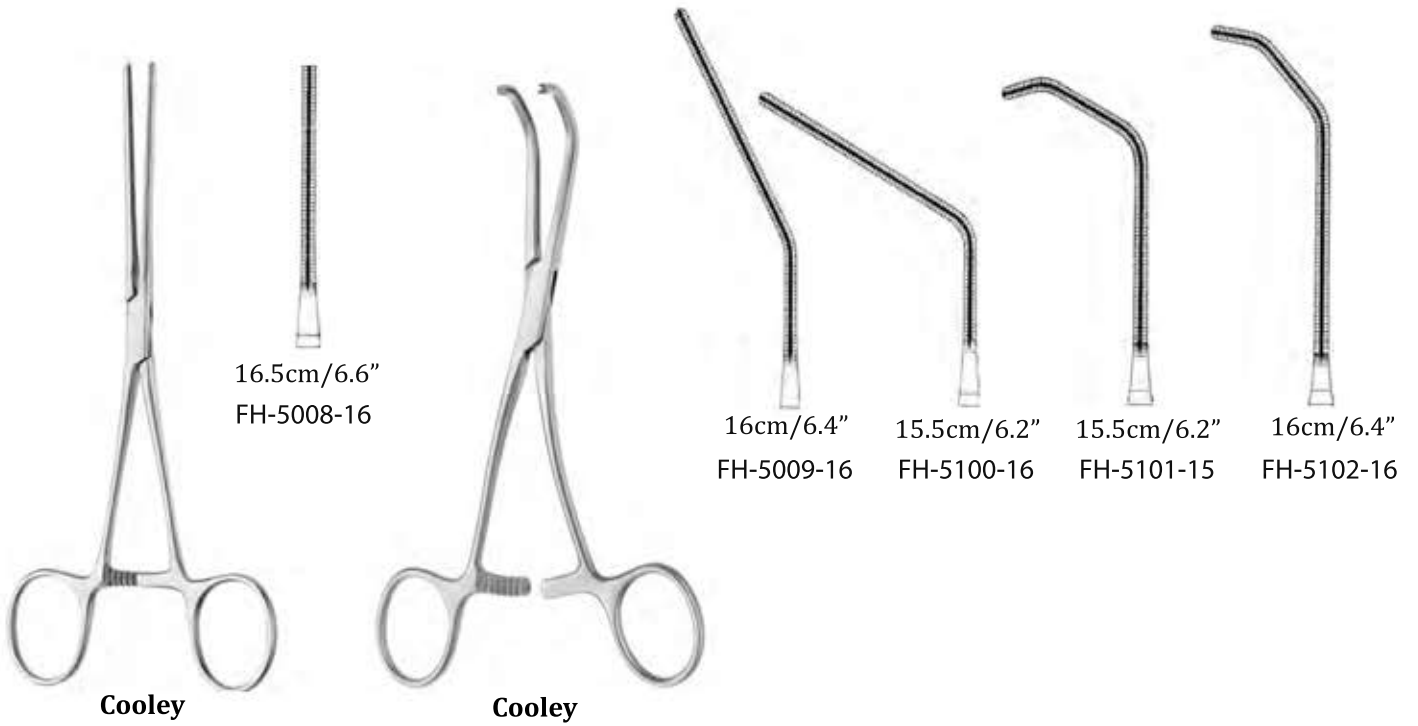



20cm/8"

Plain Jaw



12 mm
FH-6009-12



20 mm
FH-6009-20



30 mm
FH-6009-30

Atraumatic Jaw



12 mm
FH-6101-12



20 mm
FH-6101-20



30 mm
FH-6101-30

For Shunt



3 mm
FH-6105-03



5 mm
FH-6105-05



7 mm
FH-6105-07



9 mm
FH-6105-09



20cm/8"