

**Traumatologie**

**Traumatology**

**Traumatologie**

**TR**



**Percy**  
TR-1098-00



**Percy**  
TR-1100-00  
simple pattern, detachable handles



complete  
TR-1001-01 Compression Apparatus for Producing blood Vacuum in limbs

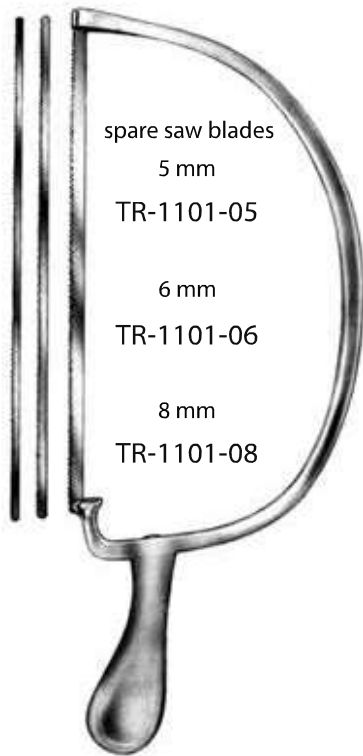

spare saw blades  
5 mm  
TR-1101-05  
6 mm  
TR-1101-06  
8 mm  
TR-1101-08

**Helferich-Bier**

39 cm/15.6"

TR-1101-39

with 1 each saw blade 5, 6 and 8 mm



spare saw blades  
12 mm  
TR-1102-12  
15 mm  
TR-1102-15  
18 mm  
TR-1102-18

**Charriere**

35 cm/14"

TR-1102-00

with 2 each saw blades 12 and 15 mm wide

Metacarpal saw



spare saw blades  
TR-1106-98  
18 cm/7.2"  
TR-1106-99  
20 cm/8"

**Charriere**

TR-1106-27 27 cm/10.8"

TR-1106-30 30 cm/12"



spare saw blades  
TR-1108-99  
19 cm/7.6"

**Satterlee**

29 cm/11.6"

TR-1108-31

**Langenbeck**

23 cm/9.2"

TR-1200-23

Finger Drill



TR-1600-01



TR-1600-00

Complete Incloding TR-1600-01

Nail Extracting forceps



**Radolf**

13.5 cm/5.4"

TR-1602-13

Finger Ring Cutters



saw blade

TR-1703-01

TR-1703-00

17 cm/6.8"



saw blade

TR-1705-01

TR-1705-00

17 cm/6.8"



**Stille**  
20 cm/8"  
TR-2100-20  
Complete

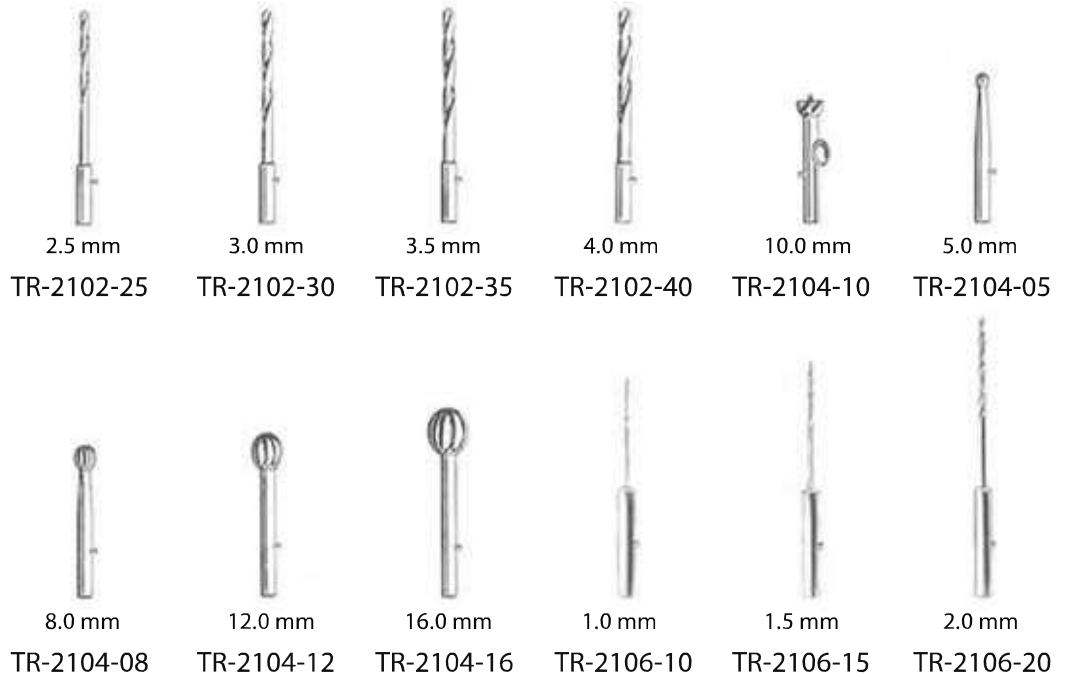

**Stille-Sherman**  
24 cm/9.6"  
Complete TR-2200-24



**Moore**  
28 cm/11.2"  
Complete TR-2300-28



Complete set including TR-2400-99 , TR-2402-09 , TR-2402-14 , TR-2402-16 , TR-2402-22 and TR-2406-00



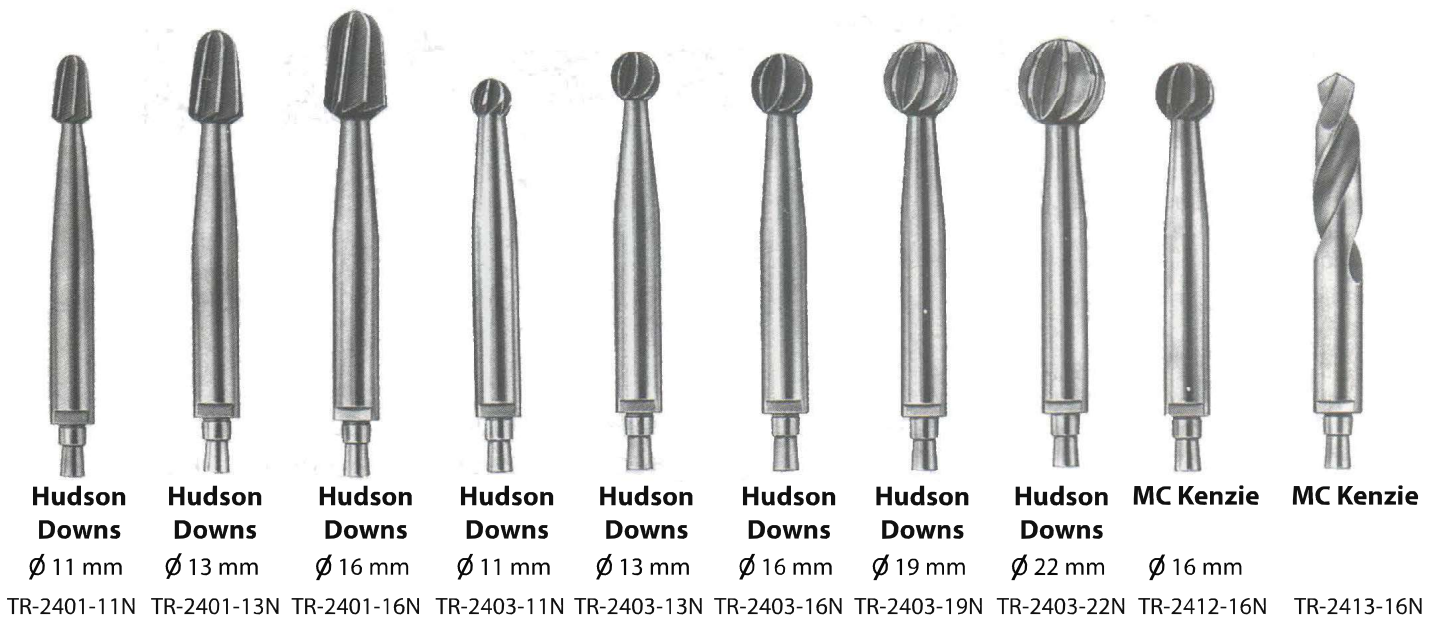
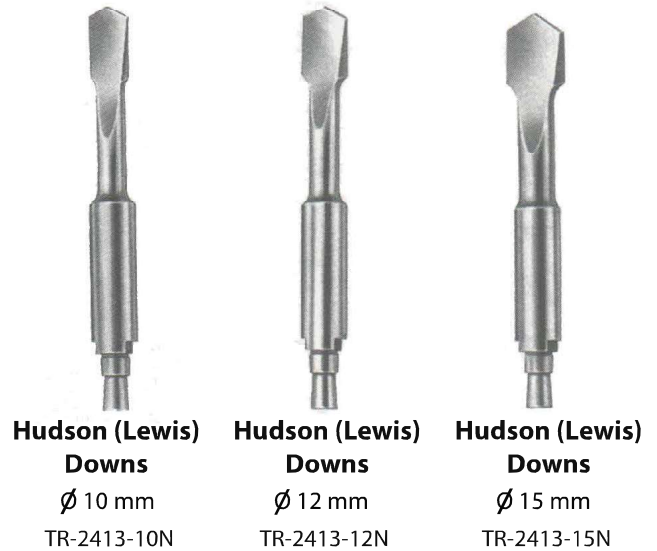
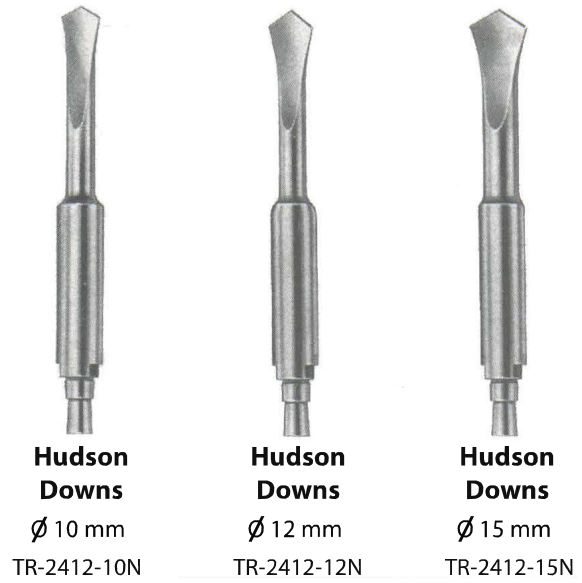



**Bunnell**  
TR-2700-00

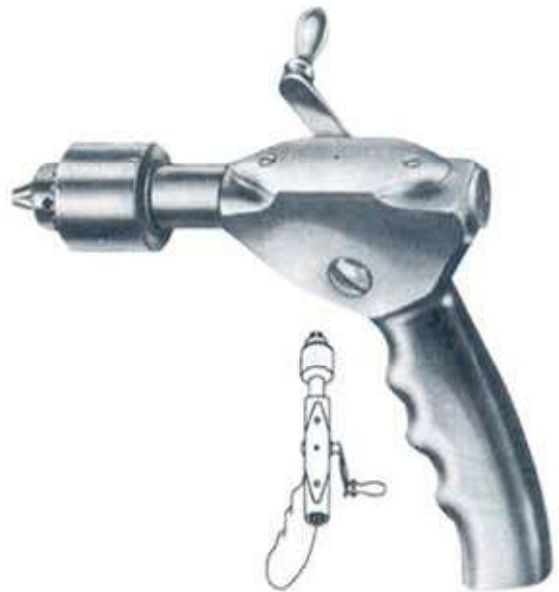

**Rolk**  
TR-2800-00

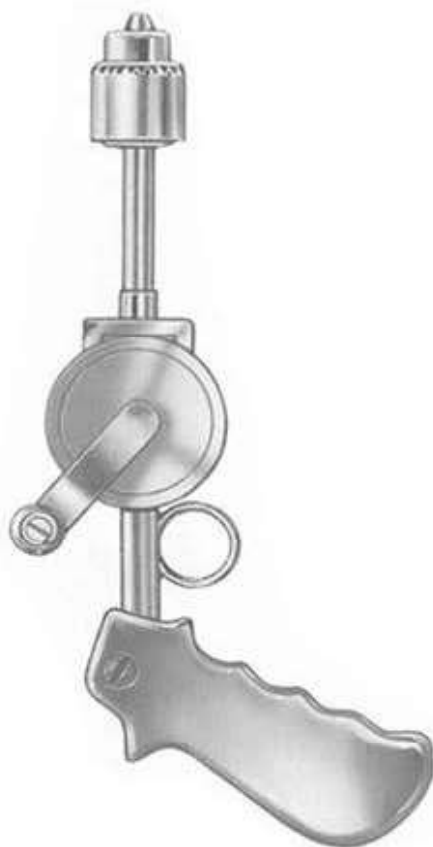

TR-2900-00

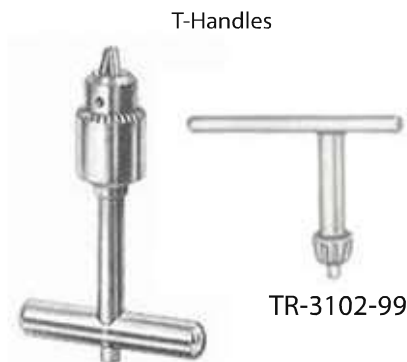

T-Handles

TR-2906-00  
including TR-3102-99

TR-3102-99

Keyless T-Handle



TR-2910-00

### Taps



Ø mm	L	XL
1.5	TR-3510-15	
2.0	TR-3510-20	TR-3511-20
2.7	TR-3510-27	TR-3511-27
3.5	TR-3510-35	(corticals)
3.5	TR-3512-35	(spong)
4.5		TR-3511-45 (1.25)
4.5		TR-3512-45 (1.75)
6.5	TR-3510-65	

small  
4.5 cm/1.8"  
TR-3510-45

### Taps W. T-Handle

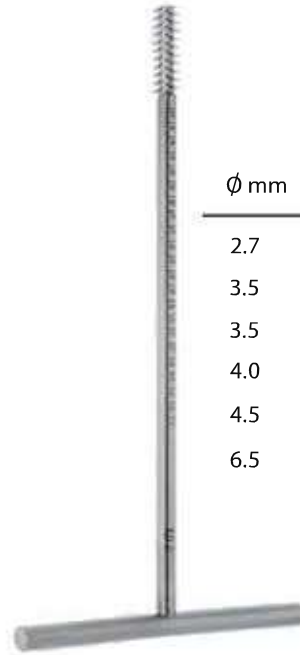

Ø mm	L	XL
2.7	TR-3514-27	
3.5	TR-3514-35 (1.25)	
3.5	TR-3515-35 (1.75)	
4.0	TR-3514-40 (1.75)	
4.5	TR-3514-45	TR-3515-45
6.5	TR-3514-65	

### Quick Chuck Handles



TR-3518-00  
cannulated



TR-3520-00  
cannulated



TR-3522-00



TR-3524-00

### Reamers



TR-3902-14  
14 cm/5.6"



TR-3904-14  
14 cm/5.6"



**Perthes**  
21 cm/8.4"  
TR-3905-21



**Perthes**  
21 cm/8.4"  
TR-3906-21

### Mandibular Awl



TR-3907-14N  
14 cm/5.6"



TR-3907-23N  
23 cm/9.2"

### Maxillary Awl



TR-3908-18N  
18 cm/7.2"



Trocar  
Round



Trocar  
Trocar

Tip  
Rear End

Ø mm	70 mm	150 mm	310 mm	150 mm	310 mm
0.8	TR-4010-08	TR-4012-08	TR-4020-08	TR-4022-08	TR-4024-08
1.0	TR-4010-10	TR-4012-10	TR-4020-10	TR-4022-10	TR-4024-10
1.2	—	TR-4012-12	TR-4020-12	TR-4022-12	TR-4024-12
1.4	—	TR-4012-14	TR-4020-14	TR-4022-14	TR-4024-14
1.5	TR-4010-15	TR-4012-15	TR-4020-15	TR-4022-15	TR-4024-15
1.6	—	TR-4012-16	TR-4020-16	TR-4022-16	TR-4024-16
1.8	—	TR-4012-18	TR-4020-18	TR-4022-18	TR-4024-18
2.0	—	TR-4012-20	TR-4020-20	TR-4022-20	TR-4024-20
2.2	—	TR-4012-22	TR-4020-22	TR-4022-22	TR-4024-22
2.5	TR-4010-25	TR-4012-25	TR-4020-25	TR-4022-25	TR-4024-25
3.0	—	TR-4012-30	TR-4020-30		



Tip : Trocar with thread  
Rear End : Round

Ø mm	mm	150 mm	200 mm	230 mm
1.6	5	TR-4030-16	—	—
1.6	15	TR-4032-16	—	—
2.0	15	TR-4034-20	—	—
2.0	15	—	TR-4036-20	—
2.5	15	—	TR-4038-20	—
2.5	20	—	—	TR-4038-23

Gauge for wire drills



**Kirschner**  
TR-4038-90



Tip : Trocar  
Rear End : Triangular

∅ mm	120 mm	150 mm	180 mm	200 mm	250 mm	300 mm
3.5	TR-4039-12	TR-4039-15	TR-4039-18	TR-4039-20	TR-4039-25	TR-4039-30
4.0	TR-4040-12	TR-4040-15	TR-4040-18	TR-4040-20	TR-4040-25	TR-4040-30
4.5	TR-4045-12	TR-4045-15	TR-4045-18	TR-4045-20	TR-4045-25	TR-4045-30
5.0	TR-4050-12	TR-4050-15	TR-4050-18	TR-4050-20	TR-4050-25	TR-4050-30



**Steinmann Pins**

∅ mm	150 mm	180 mm	200 mm	230 mm	250 mm	300 mm
3.0	TR-4130-15	TR-4130-18	TR-4130-20	TR-4130-23	—	—
3.5	TR-4135-15	TR-4135-18	TR-4135-20	TR-4135-23	—	—
4.0	TR-4140-15	TR-4140-18	TR-4140-20	TR-4140-23	TR-4140-25	—
4.5	TR-4145-15	TR-4145-18	TR-4145-20	TR-4145-23	TR-4145-25	TR-4145-30
5.0	TR-4150-15	TR-4150-18	TR-4150-20	TR-4150-23	TR-4150-25	TR-4150-30

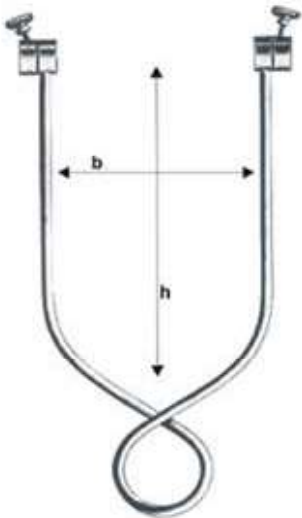

**Bohler**

hxb ( cm )

16x9	TR-5002-16
21x11	TR-5002-21
21x15	TR-5002-22



**Kirschner ( w.3 hooks )**

hxb ( cm )

6x5	TR-5102-06
9.5x7	TR-5102-09
10.5x10.5	TR-5102-10
9.5x11	TR-5102-11
12x12	TR-5102-12
13.5x13	TR-5102-13
15x15	TR-5102-15
20x15.5	TR-5102-20



**Wrench**

TR-5105-01



**Tightener**

TR-5105-02



**With 3 hooks**

hxb ( cm )

18x10	TR-5104-18
27x16	TR-5104-27



**Kirschner ( u.s )**

size cm

S	13.0	TR-5108-01
L	18.5	TR-5108-02
XL	22.0	TR-5108-03



TR-5109-01



TR-5109-02

Hooks only

### Wire Conductor



**Demel**

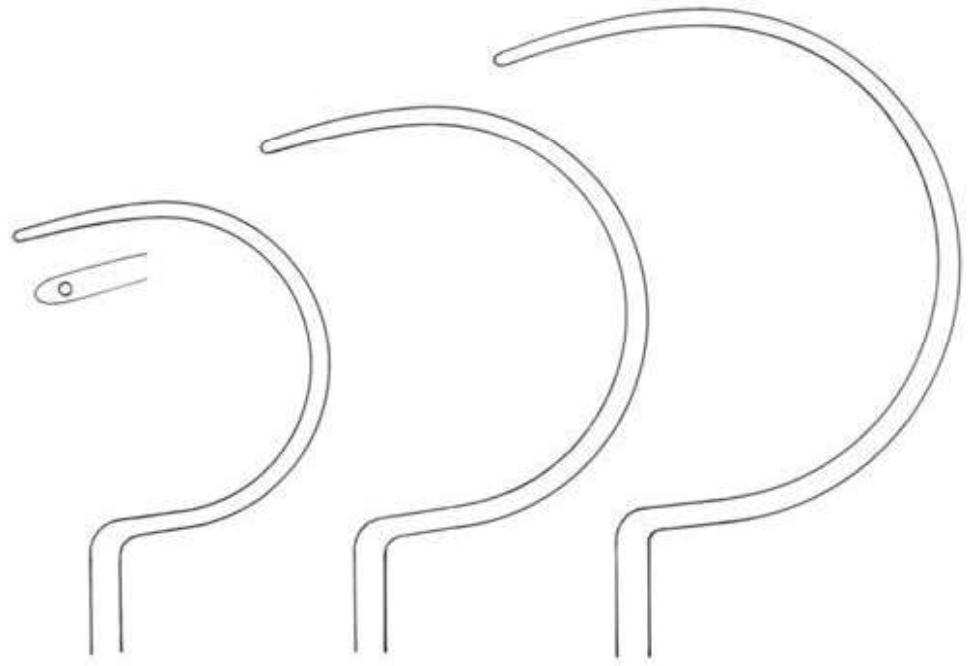

Fig. 1  
TR-5250-01

Fig. 2  
TR-5250-02

Fig. 3  
TR-5250-03

### Wire Guide



∅ 45 mm

TR-5260-45



∅ 70 mm

TR-5260-70

### Bone Wire (Soft)



**Witheye**

L (cm)	∅ mm	
28	0.8	TR-5291-08
28	1.0	TR-5291-10
28	1.2	TR-5291-12
60	1.0	TR-5292-10
60	1.2	TR-5292-12



10 mm

∅ mm

0.2	TR-5300-02
0.3	TR-5300-03
0.4	TR-5300-04
0.5	TR-5300-05
0.6	TR-5300-06
0.7	TR-5300-07
0.8	TR-5300-08
0.9	TR-5300-09
1.0	TR-5300-10
1.1	TR-5300-11
1.2	TR-5300-12
1.5	TR-5300-15

Wire Tightener



**Demel**  
28 cm/11.2"  
TR-5254-28

Wire Tension Plier



**Danis**  
28 cm/11.2"  
TR-5258-20

Wire Tightener & Twister



**Loute**  
21 cm/8.4"  
TR-5301-21



TR-5302-17  
17 cm/6.8"



TR-5306-14  
14 cm/5.6"



TR-5306-19  
19 cm/7.6"



TR-5307-01  
18 cm/7.2"



round



17 cm/6.8"



TR-5308-01  
serrated



TR-5308-02  
cross



**Hackstock**  
16 cm/6.4"  
TR-5310-16



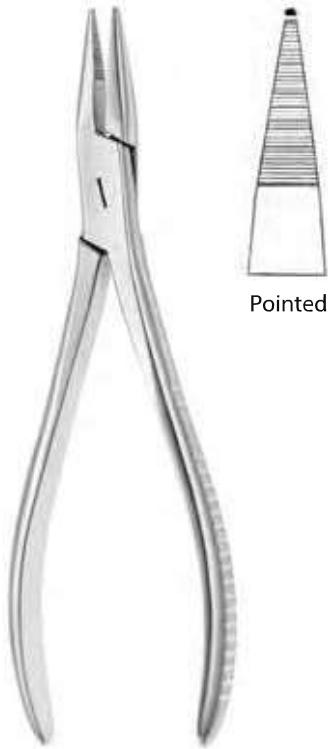

Pointed

TR-5308-19N  
19 cm/7.6"



serrated

**Maburge**  
14 cm/5.6"  
TR-5312-14



one jaw serrated

**Goslee**  
14 cm/5.6"  
TR-5314-14



**Parallel, Cutting**  
18 cm/7.2"  
TR-5318-18



**TC, Parallel**  
18 cm/7.2"



Fig. 1

TR-5324-01



Fig. 2

TR-5324-02



Fig. 3

TR-5324-03

### Seizing Forceps



**Vise Grip**  
18 cm/7.2"  
TR-5303-18

### Extracting Forceps



TR-5305-13 13 cm/5.2"  
TR-5305-18 18 cm/7.2"

### Bending Forceps



TR-5304-15  
15 cm/6"



18 cm/7.2"



Fig. 2

TR-5307-02



Fig. 3

TR-5307-03



Fig. 4

TR-5307-04



18 cm/7.2"



5 mm

TR-5326-18



7 mm

TR-5328-18



TR-5320-15 15 cm/6"	TR-5320-20 20 cm/8"	TR-5321-15 15 cm/6"



Heavy  
TR-5322-18

**Berry**  
18 cm/7.2"



TR-5208-01N 15 cm/6"	TR-5208-02N 15 cm/6"	TR-5208-03N 16 cm/6.4"	TR-5208-04N 18 cm/7.2"

**Automatic**



TR-5502-17N  
17 cm/6.8"

Cannulated



TR-5400-16  
16 cm/6.4"

For Soft Wire mm 2.2  
For Hard Wire mm 2.0



TR-5402-15  
15 cm/6"

2.0  
1.5



TR-5500-18  
18 cm/7.2"

1.7  
1.7



TR-5704-15N  
12 cm/4.8"

For Soft Wire mm 0.7  
For Hard Wire mm 0.5



TR-5404-18N  
18 cm/7.2"

2.0  
1.5



TR-5403-15N  
15 cm/6"

2.0  
1.0



TR-5401-22  
22 cm/8.8"

For Soft Wire  $\varnothing$  mm 3.5

For Hard Wire  $\varnothing$  mm 2.5



TR-5405-22  
22 cm/8.8"

2.0

1.5



TR-5406-18  
18 cm/7.2"

For Soft Wire  $\varnothing$  mm 2.0

For Hard Wire  $\varnothing$  mm 1.6



TR-5407-17  
17 cm/6.8"



23 cm/9.2"

For Soft Wire  $\varnothing$  mm 3.0

For Hard Wire  $\varnothing$  mm 2.0



TR-5408-23 TR-5409-23



TR-5505-24

24 cm/9.6"

2.0

1.6



TR-5506-48 48 cm/19.2"

TR-5506-56 56 cm/22.4"

up to 6 mm



TR-5508-48 48 cm/19.2"

### Intramedullary Reamers



∅ mm

TR-5600-24	2.4
TR-5600-32	3.2
TR-5600-48	4.8
TR-5600-64	6.4

### Medullary Cavity Reamers



**Kuentscher**  
26 cm/10.4"

∅ mm

TR-5701-08	8
TR-5701-10	10
TR-5701-12	12.5

### Femur Reamer



**Kuentscher**  
35 cm/14"

TR-5703-35

### Nail Impactor extractor



F. / P. ∅ mm 2.4

TR-5602-24



3.2

TR-5602-32



4.8

TR-5602-48



6.4

TR-5602-64



**Lloyd**

20 cm/8"

TR-6002-20



Guide Pins

∅ mm	L = 35 cm	46 cm	60 cm
2.5	TR-5801-35	TR-5801-46	—
3.0	TR-5802-35	TR-5802-46	TR-5802-60
3.5	TR-5803-35	TR-5803-46	TR-5803-60
4.0	TR-5804-35	TR-5804-46	TR-5804-60
5.0	TR-5805-35	TR-5805-46	TR-5805-60



Extractor

**Kuentscher**  
63 cm/25.2"  
TR-5900-00



Hammer

**Slotted**  
30 cm/12"  
TR-5908-30

Nail Drivers



**Kuentscher**  
21 cm/8.4"  
TR-5806-21



**Kuentscher**  
21 cm/8.4"

∅ mm	
6-8	TR-5807-13
9-12	TR-5807-17
13-20	TR-5807-21

Extraction Hooks



Fig. 1

TR-5900-01



Fig. 2

TR-5900-02



Fig. 2

TR-5900-03



Fig. 4

TR-5900-04



L cm

29	TR-5906-29
37	TR-5906-37
42	TR-5906-42
49	TR-5906-49



**Williams**  
24 cm/9.6"  
TR-6204-24



1.5 mm  
TR-6208-15



2.5 mm  
TR-6208-25  
3.5 mm  
TR-6208-35



**Phillips**  
TR-6212-25



17 cm/6.8"  
TR-6214-17  
25 cm/10"  
TR-6214-25



1.5 mm  
TR-6259-15



2.5 mm  
TR-6259-25



3.5 mm  
TR-6259-35



1.5 mm  
TR-6300-15



2.5 mm  
TR-6300-25

TR-6300-99



**Lane**  
TR-6302-25

### Screw Holding Forceps



**Lane**  
18 cm/7.2"  
TR-6305-18N



**Lane**  
23 cm/9.2"  
TR-6307-23N



**Self Retaining**  
8 cm/3.2"  
TR-6350-08

### Plate Holding Forceps



**Small Plates**  
12 cm/4.8"  
TR-6303-13



**Lane**  
22 cm/8.8"  
TR-6309-22N

### Plate Bender ( Bending Iron )



**Mini Plates**  
13 cm/5.2"  
TR-6402-00



**Small Plates**  
14.5 cm/5.8"  
TR-6403-01



**Small Plates**  
14.5 cm/5.8"  
TR-6403-02



**Standard Plates**  
24 cm/9.6"  
TR-6405-00

### Bending Pliers ( Forceps )



TR-6498-14  
14 cm/5.6"



TR-6500-14  
14 cm/5.6"



TR-6502-22  
22 cm/8.8"

Bending Plier



TR-6503-25  
25 cm/10"

Bending Device



TR-6700-00

Bending Template



Holes	mm	
5	90	TR-6704-09
7	120	TR-6704-12
9	150	TR-6704-15
12	200	TR-6704-20
7	60	TR-6706-06
9	85	TR-6706-08

Cannulated Drill Bit

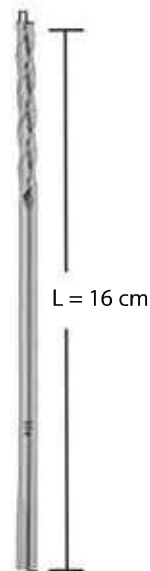

∅ mm	A	
2.7	1.35	TR-7900-27
3.2	1.75	TR-7900-32
3.5	1.35	TR-7900-35
4.5	1.75	TR-7900-45
5.0	2.0	TR-7900-50

Tap sleeve / Drill Sleeve



2.7 / 1.0  
TR-7910-27

### Taps



Ø mm

3.5	TR-8102-35
4.0	TR-8102-40
4.5	TR-8102-45



TR-8104-00



Ø 7 mm

TR-8102-70

### Screw Drivers ( Hexagonal )



SW ( mm )

2.5	TR-8106-25
3.5	TR-8106-35

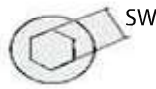

SW ( mm )

5.0	TR-8106-50
-----	------------

### Screw Holder



TR-8107-25 for 2.5 mm

TR-8107-35 for 3.0 mm

### Direct Screw Length Gauge



7 mm  
TR-8110-70



4.5 mm  
TR-8114-45



3.5 mm  
TR-8120-35

### canal Brush



2.1 mm  
TR-8111-21



1.75 mm  
TR-8115-17



1.35 mm  
TR-8121-13

### canal Cleaner



2 mm  
TR-8112-20



1.6 mm  
TR-8116-16



1.2 mm  
TR-8121-12

Parallel Aiming Device



For Screws 7 mm  
TR-8192-00  
For Guide Wires 2 mm

Tissue Protector Sleeve



TR-8200-00  
For Cannulated Screws 7 mm

Countersinks



1.5/2.0 mm  
TR-8201-11  
For mini screws



2.7/3.5/4 mm  
TR-8202-20  
For small screws



screws 4.5 mm  
TR-8204-32  
Malleolar



4.5/6.5 mm  
TR-8206-45  
For large screws

### Depth Gauge



Mini

Small

Large

L TR-8207-00  
XL TR-8207-01

L TR-8208-00  
XL TR-8208-01

TR-8209-01

### Measuring Gauge



TR-8300-00

### Holding Clamp



2.0 mm TR-8402-20  
2.7 mm TR-8402-27  
3.5 mm TR-8402-35

For small Plates

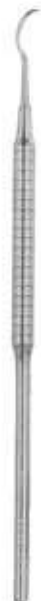

TR-8410-00  
Sharp  
Hook



TR-8700-15  
1.1/1.5 mm  
TR-8700-20  
1.1/2.0 mm  
Mini Drill Sleeve



TR-8702-20  
2.0 mm  
Drill Guide and  
Drill Sleeve

Insert Drill Sleeve



mm	
2.7/2.0	TR-8704-27
3.5/2.5	TR-8704-35
4.5/3.2	TR-8704-45

Drill Guide



C. Clamp W. Thread	
mm	
3.5	TR-8800-35
4.5	TR-8800-45



**Pointed**  
TR-8801-45



**W. Adjustable Stop**  
TR-8803-45

Tap Sleeve



3.5 mm  
TR-8805-35  
For Tap 2.7 mm



mm	
2.7/2.0	TR-8807-27
3.5/2.5	TR-8807-35

For 3.5 mm Cortex Screw



4.5 mm  
TR-8809-45  
For Large cannulated Screws