

Tonsillen

Tonsils

Les amygdales

AM



Love

W (width) 15 cm/6" w

18 mm	AM-1003-18
20 mm	AM-1003-20
22 mm	AM-1003-22



Hofer

24 cm/9.6"
 AM-1009-24



Nager

23 cm/9.2"
 AM-1101-23



Haslinger

17 cm/6.8"
 AM-1200-17N



Schoenborn

21 cm/8.4"
 TQ-5101-21



Dupuy-Weiss
22 cm/8.8"
AM-1605-22



Dupuy-Weiss
22 cm/8.8"
AM-1607-22



Hurd
21 cm/8.4"
AM-1609-21



Hurd
21 cm/8.4"
AM-1611-21



Nager
24 cm/9.6"
AM-1613-24



Falk

24 cm/9.6"

AM-1614-24N

Falk

24 cm/9.6"

AM-1615-24N



Trelat

23 cm/9.2"

AM-1616-23N



Clous-Eicken

23 cm/9.2"

AM-1617-23N



Deschamps

21 cm/8.4"

SR-1100-21

SR-1101-21

sharp

Ligature Carrier



Roeder

26 cm/10.4"

AM-1620-26

Gauze Packer

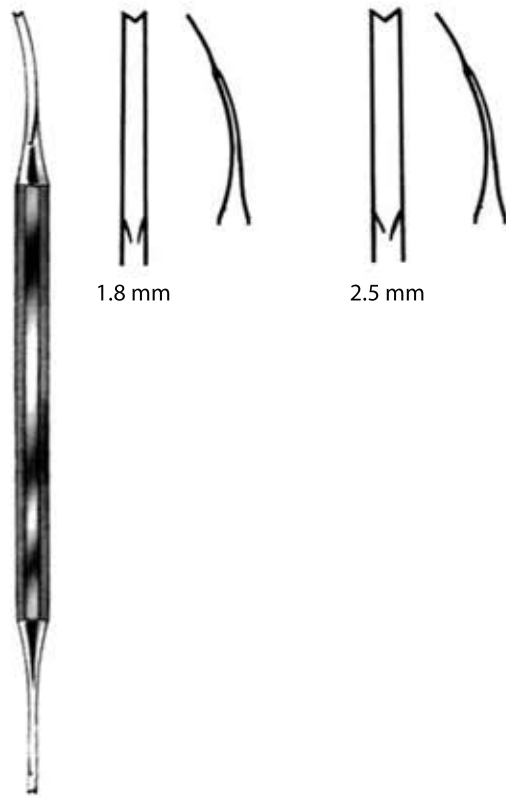

1.8 mm

2.5 mm

Luniatschek

19 cm/7.6"

AM-1501-19 1.8 mm

AM-1501-25N 2.5 mm

Knot Tyer



Negus

23 cm/9.2"

SR-2904-23

Suture Catcher



Claus

23.5 cm/9.4"

SR-2550-23N

Tonsil Knives



Fisher
22.5 cm/9"
AM-1631-22



Abraham
21 cm/8.4"
AM-1633-20



Canfield
21 cm/8.4"
AM-1635-21



Bruenings
23 cm/9.2"
AM-1637-23N

Septum Knives



Freer
19 cm/7.6"
RN-3705-19



Bruenings
16.5 cm/6.6"
RN-3908-16



Ballenger
22 cm/8.8"
RN-3900-03 3 mm
RN-3900-04 4 mm
RN-3900-05 5 mm



Ballenger
22 cm/8.8"
RN-3902-03 3 mm
RN-3902-04 4 mm
RN-3902-05 5 mm

with swivel blades

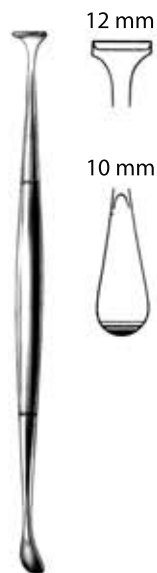

Hurd
22 cm/8.8"
smooth serrated
AM-1301-22 AM-1303-22



Henke
23 cm/9.2"



Carpenter
25 cm/10"
AM-1309-25



Carpenter
24 cm/9.6"
AM-1403-24



Mollinson
21 cm/8.4"
AM-1405-21N



Gwyne-Evans
20 cm/8"
AM-1406-20N 6 mm
AM-1408-20N 8 mm



Syme
18.5 cm/7.4"
AM-1407-18N



Freer (Gorney)
21 cm/8.4"
RN-6515-21



Colver
19 cm/7.6"



White
AM-2005-18 19 cm/7.6"
AM-2005-23 23 cm/9.2"

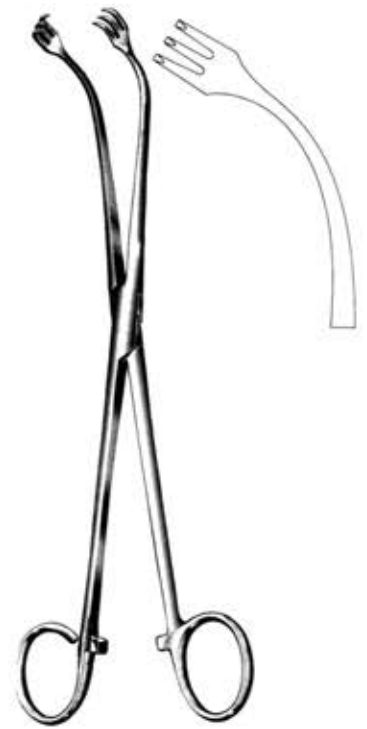

Ballenger
21,5 cm/8.6"
AM-2007-21



Blohmke
20 cm/8"
AM-2009-20



Marschik-Kroni
20 cm/8"
AM-2010-20N



Museux
20 cm/8"
AM-2012-20N straight
AM-2013-20N curved



Tivnen
AM-2103-21

21 cm/8.4"



Tyding
AM-2101-21



Denis-Browne
20 cm/8"
AM-2104-20N



Marschik
22 cm/8.8"
AM-2109-22



Abraham
20 cm/8"
AM-2110-20N



Wilson
19 cm/7.6"
AM-2111-19N



Eves
28 cm/11.2"
AM-2500-28



Eves
28 cm/11.2"
AM-2502-28



Brueninges
28 cm/11.2"
AM-2506-28



AM-2507-40 40 mm
AM-2507-50 50 mm
Pack of 100 pcs



AM-2509-03 0.3 mm
AM-2509-04 0.4 mm
AM-2509-05 0.5 mm
Pack of 12 pcs



Tyding
AM-2600-00
with (1) straight tip



Brown
AM-2700-00N
with (1) straight tip



Fig. 3



Fig. 2



Fig. 3



Sluder-Ballenger

AM-2700-00
complete with (3) blades



Daniels

AM-2800-16 16 mm
AM-2800-20 20 mm
AM-2800-24 24 mm

complete with (1) blade



24 mm
AM-2801-24



20 mm
AM-2801-20



16 mm
AM-2801-16



blade only

Tonsil Hemostat



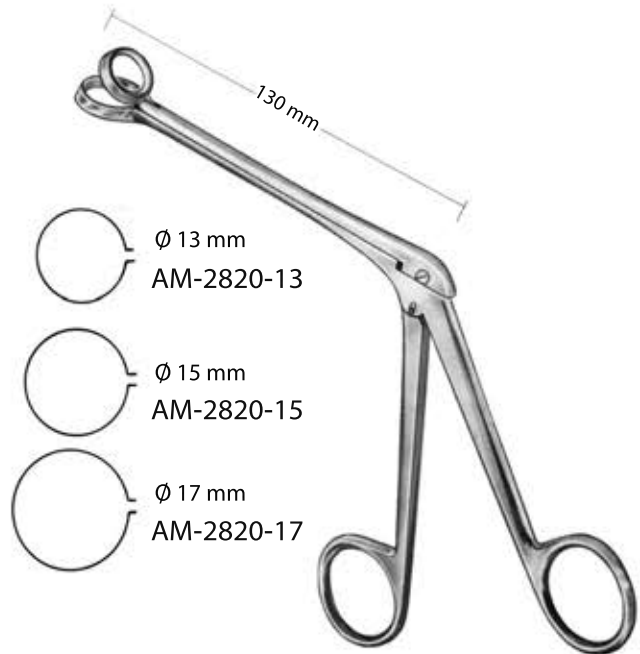



Crowin
14 cm/5.6"
AM-2301-14





-  Ø 13 mm
AM-2820-13
-  Ø 15 mm
AM-2820-15
-  Ø 17 mm
AM-2820-17

Hartmann



-  Ø 5 mm
AM-2830-05N
-  Ø 7 mm
AM-2830-07N
-  Ø 9 mm
AM-2830-09N
-  Ø 11 mm
AM-2830-11N

Hartmann

-  Ø 5 mm
AM-2840-05N
-  Ø 7 mm
AM-2840-07N
-  Ø 9 mm
AM-2840-09N



Schmeden

Tonsil Syringe



- AM-2900-02 2 ml
- AM-2900-05 5 ml
- AM-2900-10 10 ml
- AM-2900-20 20 ml

Tonsil Needles



AM-2902-00
straight



AM-2903-45



AM-2903-90

Abcess Forceps

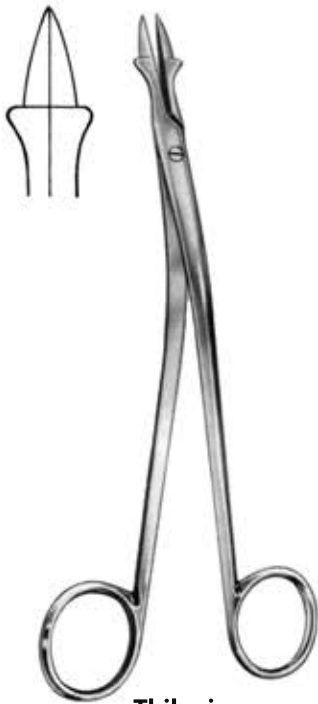

Thilenius
19 cm/7.6"
AM-2910-19N

Dressing Forceps



Duplay
20 cm/8"
PP-2407-20

Gelfoam Pressure Forceps

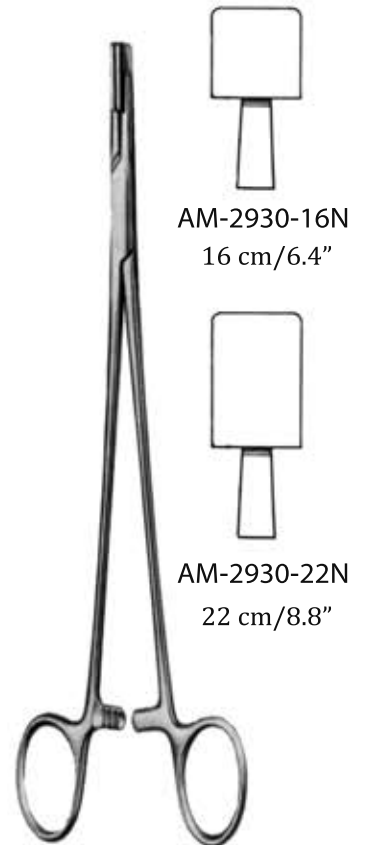

AM-2930-16N
16 cm/6.4"

AM-2930-22N
22 cm/8.8"

House