

**Neurochirurgie und Laminektomie**

**Neurosurgery and Laminectomy**

**Neurochirurgie et Laminectomie**

**NE**

### Clip Applying Forceps



**Mckenzie**

NE-0101-15 15 cm/6"  
NE-0101-19 19 cm/7.6"



**Mckenzie**

NE-0103-15 15 cm/6"  
NE-0103-19 19 cm/7.6"



**Smithwick**

NE-0105-23 23 cm/9.2"  
NE-0105-26 26 cm/10.4"

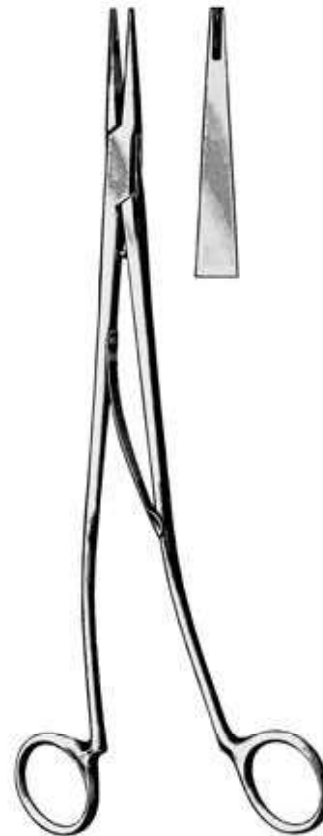

**Sweet**

NE-0107-23 23 cm/9.2"  
NE-0107-26 26 cm/10.4"

### Clip Bending and Cutting Forceps

Clip Applying Forceps

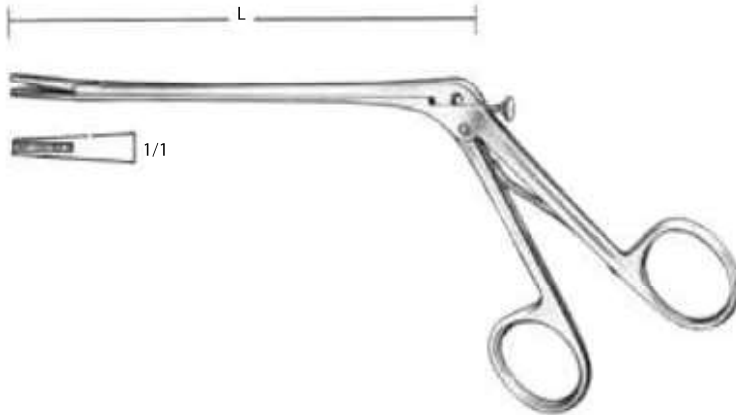

**Olivercona - Toennis**  
NE-0109-14 14 cm/5.6"  
NE-0109-20 20 cm/8"



**Mckenzie**  
18 cm/7.2"  
NE-0110-18N

Applyin and removing forceps



**Raney**  
15,5 cm/6.2"  
NE-0208-00

scalp clips



**Raney**  
NE-0207-00



**Kolner**  
NE-0210-00

Silver Wires



**Mckenzie**  
NE-0110-25N

Clip Carrier



**Mckenzie**  
148x40x6 mm NE-0200-00  
One clip holding



**Mckenzie**  
190x48x13 mm NE-0200-02  
Two clips holding

Silver clips



NE-0201-00  
contains 100 pieces



### Skull Traction Tongs



175 mm

NE-0204-00



NE-0204-10  
spare pin



105 mm

NE-0205-01



155 mm

NE-0205-02



NE-0206-35  
7 cm/2.8"  
Ø 3,5 mm



NE-0206-50  
7 cm/2.8"  
Ø 5,0 mm  
Drill point

### Galea Hooks



**Yasargil**  
31 cm/12.4"  
NE-0490-31



**Yasargil**  
41 cm/16.4"  
NE-0490-41

### Dura Protecting Forceps



**Adson**  
15 cm/16"  
NE-0495-15

### Wire Saw Guide



1/2

#### DeMartel (Bailey)

33 cm/13.2"

NE-0900-33

Flexible



#### Lebsche

25 cm/10"

NE-0901-25

### Wire Saw

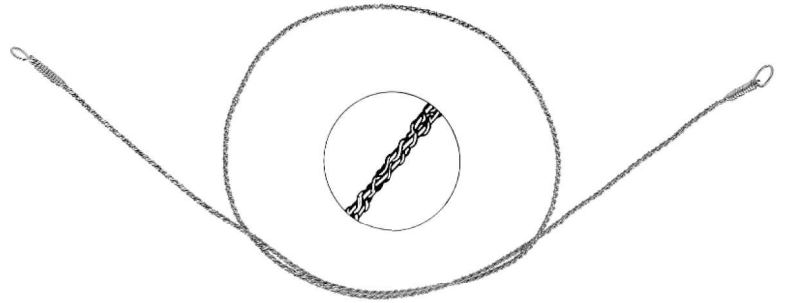

cm	inch.	soldered	coarse	fine
30	12	NE-0902-30	NE-0901-30	NE-0904-30
40	16	NE-0902-40	NE-0901-40	NE-0904-40
50	20	NE-0902-50	NE-0901-50	NE-0904-50
60	24	NE-0902-60	NE-0901-60	NE-0904-60
70	28	NE-0902-70	NE-0901-70	NE-0904-70

**Olivecrona**

**Gigli**

**Olivecrona-Gigli**

### Wire Handles

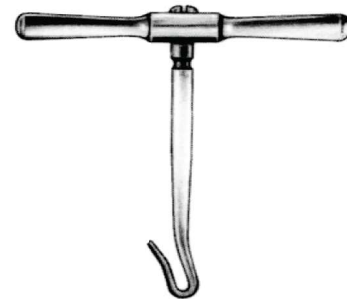

#### Gigli

NE-0904-00



#### Gigli

NE-0905-00

Bore hole protection forceps



NE-0905-20  
20 cm/8"

Skull punches



**Devilbiss**  
21 cm/8.4"  
NE-0906-21

Skull punches



**Dahlgren**  
20 cm/8"  
NE-0907-20



**Cone**  
NE-0908-20 20 cm/8"  
NE-0908-23 23 cm/8"



1/2 left  
**Dandy**  
20 cm/8"  
NE-0501-20



1/2  
**Dandy**  
20 cm/8"  
NE-0502-20



1/2 right  
**Dandy**  
20 cm/8"  
NE-0503-20



1/2  
**Crile**  
20 cm/8"



1/1  
NE-0504-01  
Fig. 1



NE-0504-02  
Fig. 2



1/2  
**Cushing**



1/1  
Fig. 1 19 cm/7.6" NE-0506-19



1/1  
Fig. 2 NE-0508-19

28 cm/11.2"  
NE-0506-28 NE-0508-28



1/2  
**Graham**  
16,5 cm/6.6"  
NE-0601-16



1/1  
**Sachs**  
18,5 cm/7.4"  
NE-0604-18

### Mucosa Hooks



**Freer**  
15 cm/6"  
SE-2108-15

### Dura Hooks



**Cairns**  
13 cm/5.2"  
SE-2006-13



**Lahey**  
13 cm/5.2"  
NE-0602-13



**Cushing**  
14,5 cm/5.8"  
NE-0606-14

### Nerve Hooks



**Hone**  
23 cm/9.2"  
NE-0600-23



**Adson**  
20 cm/8"  
NE-0608-20



**Adson**  
20 cm/8"  
NE-0609-20



**Groningen**

### Nerve Hooks



NE-0700-17  
17 cm/6.8"

**Smithwick**



NE-0700-21  
21 cm/8.4"



**Smithwick**  
29 cm/11.6"  
NE-0700-29

### Nerve Dissectors



**Scoville**  
30 cm/12"  
NE-0700-30



**Scoville**  
30 cm/12"  
NE-0701-30

### Nerve Root Retractors



**Scoville**  
23 cm/9.2"  
NE-0404-23

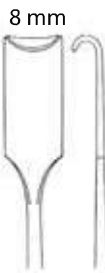

8 mm



**Holscher**  
24 cm/9.6"  
NE-0405-24



7 mm



**O'Connell**  
22 cm/8.8"  
NE-0406-22



NE-0409-21  
21 cm/8.4"



**Love**  
21 cm/8.4"  
NE-0701-21



**Caspar**  
24 cm/9.6"  
6 mm NE-0702-06  
8 mm NE-0702-08  
10 mm NE-0702-10



**Hess**  
17,5 cm/7"



**Love**  
19 cm/7.6"  
NE-0800-19



**Love**  
19 cm/7.6"  
NE-0801-19



**Love**  
19 cm/7.6"  
NE-0803-19

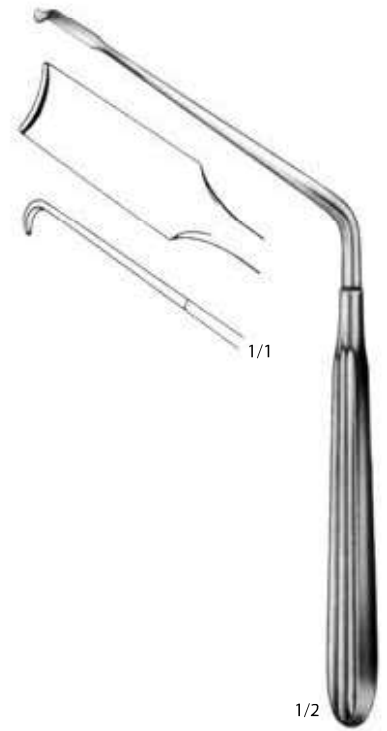

**Scoville**  
20 cm/8"  
NE-0807-20



**Olivecrona**

19,5 cm/7.8" 24 cm/9.6"  
NE-1391-19 NE-1391-24



**Olivecrona**

18,5 cm/7.4" 24 cm/9.6"  
NE-1393-18 NE-1393-24

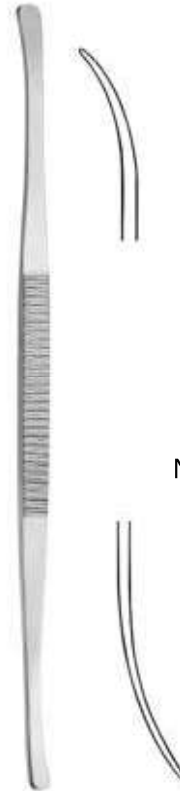

**Toennis**

25 cm/10"

Fig. 1

NE-1401-25

Fig. 2

NE-1402-25



**Sachs**

21 cm/8.4"  
NE-1403-21



**Sachs**

21 cm/8.4"  
NE-1405-21

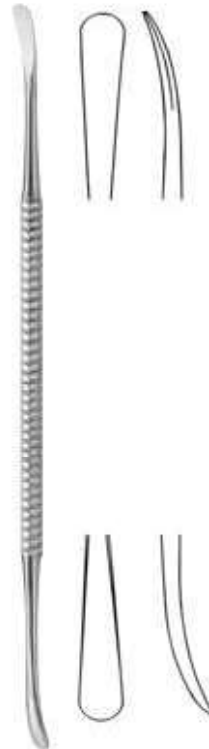

**Milligan**

22 cm/8.8"  
NE-1407-21



**Pennybaker**

23 cm/9.2"  
NE-1409-22

### Dura Dissectors



**Davis**  
24,5 cm/9.8"  
NE-1501-24



**Sachs**  
21 cm/8.4"  
NE-1503-21

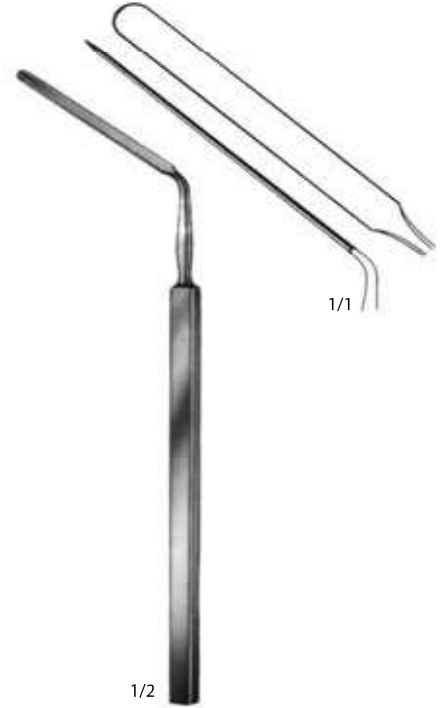

**Horsley**  
20 cm/8"  
NE-1505-20



**Yasargil**  
19,5 cm/7.8"  
for Children NE-1507-19 4 mm  
for Adults NE-1509-19 7 mm  
with flexible shaft

### Dura Separators



**Frazier**  
15 cm/6"  
NE-1711-15



**Hoehn**  
15 cm/6"  
NE-1713-15



**Hoehn**  
15 cm/6"  
NE-1715-15



**Cairns**  
17 cm/6.8"  
NE-1002-17N



**Partsch**  
15 cm/6"



3.2 mm

NE-1302-01N



4.6 mm

NE-1302-02N



**Lange**  
14,5 cm/5.8"  
NE-1302-14



4 mm



**Lempert**  
16,5 cm/6.6"  
NE-1303-16N



3.2 mm

blunt



**Lempert**  
18,5 cm/7.4"  
NE-1304-18N

6.3 mm



semi sharp



**St. Clair Thompson**  
16 cm/6.4"  
sharp NE-1306-16N  
blunt NE-1308-16N

4 mm



**Halle**  
16 cm/6.4"  
NE-1309-16N

3.5 mm



3 mm



**Sunday**  
23 cm/9.2"  
blunt NE-1400-23N

Aneurysm Needle



**Adson**  
22 cm/8.8"  
NE-0708-22

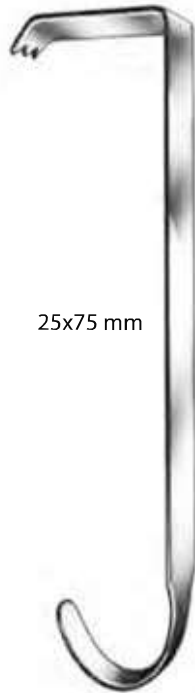

25x75 mm

**Hibbs**  
24 cm/9.6"  
NE-0810-23

Cordotome



**Frazier**  
18 cm/7.2"  
NE-1607-18

Trigeminal Knives



NE-1607-23  
23 cm/9.2"



<sup>1/2</sup>  
**Olivecrona**  
19 cm/7.6"  
NE-1607-19



**Toennis**



NE-1700-13  
13 cm/5.2"



NE-1700-19  
19 cm/7.6"

Dura Knives



**Halle**  
20 cm/8"  
NE-1700-20



**Ball-and Socket Joint,**  
NE-2200-01



**Holding Rod, head**  
NE-2200-02



**Coupling Head**  
NE-2200-03



NE-2200-05

Fixation Base, for skull mounting,  
holding 1 flexible arm



NE-2200-06

Fixation Base, for skull mounting,  
holding 2 flexible arms



NE-2200-07

Fixation Base, for mounting to bars up to,  
16 mm diam., holding 1 flexible arm



**Flexible arm only**  
NE-2200-08



**Support for flat brain spatula**  
NE-2200-09



**Support for brain spatula with round shaft**  
NE-2200-10



**Holder for ear spatula**  
NE-2200-12

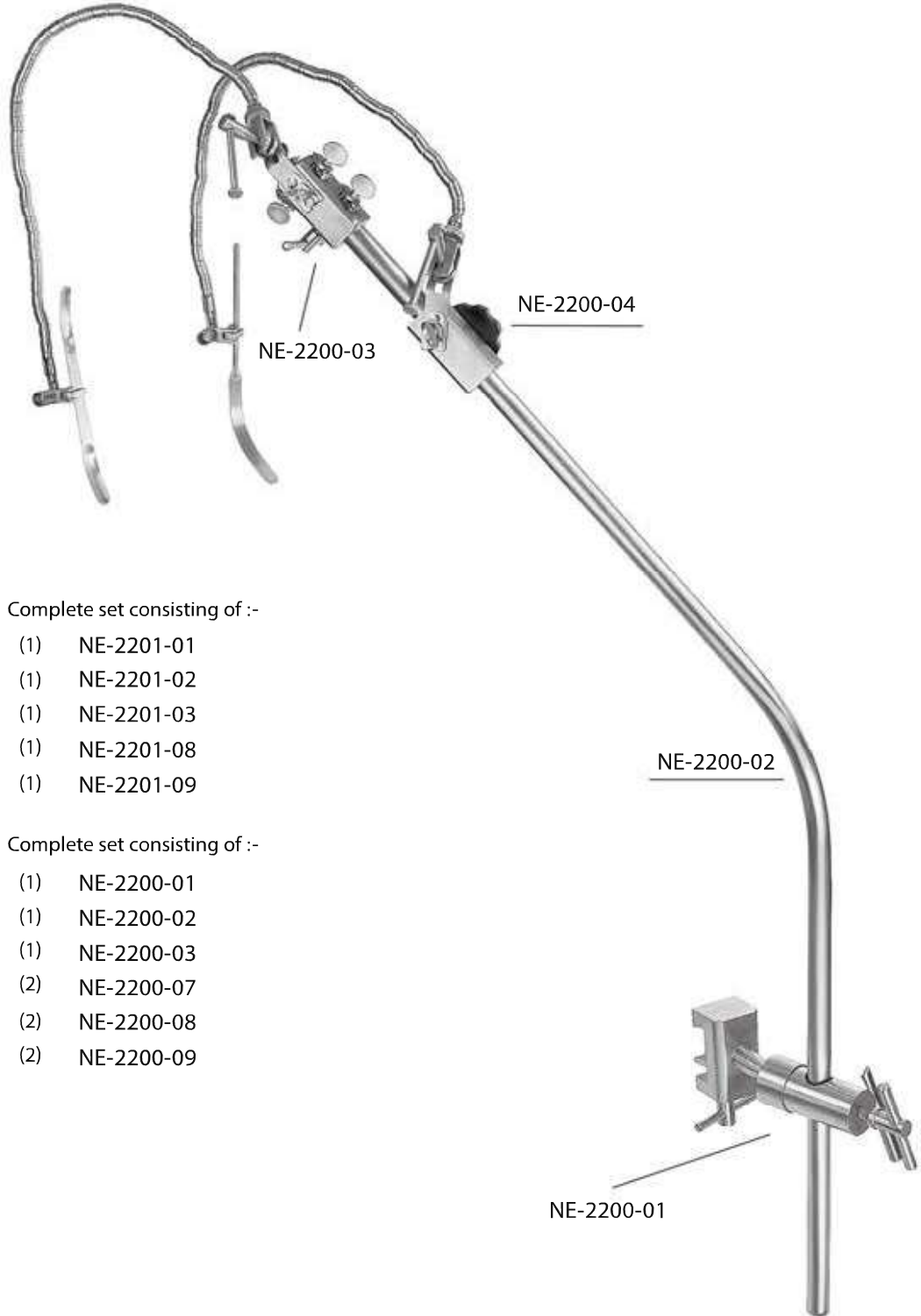

### Sets

NE-2201-01 Complete set consisting of :-

- (1) NE-2201-01
- (1) NE-2201-02
- (1) NE-2201-03
- (1) NE-2201-08
- (1) NE-2201-09

NE-2202-02 Complete set consisting of :-

- (1) NE-2200-01
- (1) NE-2200-02
- (1) NE-2200-03
- (2) NE-2200-07
- (2) NE-2200-08
- (2) NE-2200-09

NE-2201-00

Complete brain retractor set with (1) arm consisting of :-

- (1) NE-2200-05
- (1) NE-2200-08
- (1) NE-2200-09



NE-2201-00

NE-2202-02

Complete brain retractor set with (2) arms consisting of :-

- (1) NE-2200-06
- (2) NE-2200-08
- (1) NE-2200-09



NE-2202-02

malleable



**Cushing**

width 18 cm/7.2"

7/9 mm	NE-2500-07
11/13 mm	NE-2500-11
15/18 mm	NE-2500-15
18/22 mm	NE-2500-18



**Olivecrona**

width 18 cm/7.2"

7/9 mm	NE-2502-07
11/13 mm	NE-2502-11
15/18 mm	NE-2502-15
18/22 mm	NE-2502-18



**Olivecrona (Concave)**

width 18 cm/7.2"

7/9 mm	NE-2503-07
11/13 mm	NE-2503-11
15/18 mm	NE-2503-15
18/22 mm	NE-2503-18



**Scoville**

width 20 cm/8"

10/13 mm	NE-2504-10
16/19 mm	NE-2500-16



**Aachen**

width 20 cm/8"

7/8 mm	NE-2506-07N
10/11 mm	NE-2506-10N
13/14 mm	NE-2506-13N
16/17 mm	NE-2506-16N
19/20 mm	NE-2506-19N
22/25 mm	NE-2506-22N



width length

9 mm	200 mm	NE-2507-01
12 mm	200 mm	NE-2507-02
12 mm	250 mm	NE-2507-03

malleable



**Carins (Davis)**

width	20 cm/8"
6 mm	NE-2508-06
8 mm	NE-2508-08
10 mm	NE-2508-10
11 mm	NE-2508-11
13 mm	NE-2508-13
16 mm	NE-2508-16
19 mm	NE-2508-19
25 mm	NE-2508-25



**Heifetz**

width	15.5 cm/6.2"
8 mm	NE-2509-08
11 mm	NE-2509-11
14 mm	NE-2509-14
17 mm	NE-2509-17



**Heifetz**

width	20 cm/8"
8 mm	NE-2600-08
11 mm	NE-2600-11
14 mm	NE-2600-14
17 mm	NE-2600-17
20 mm	NE-2600-20



**Ribbon**

width	20 cm/8"
6 mm	NE-1608-06
7 mm	NE-1608-07
9 mm	NE-1608-09
12 mm	NE-1608-12
17 mm	NE-1608-17
20 mm	NE-1608-20
25 mm	NE-1608-25



**Ribbon**

width	33 cm/13.2"
13 mm	NE-1700-13
19 mm	NE-1700-19
25 mm	NE-1700-25
30 mm	NE-1700-30
32 mm	NE-1700-32
40 mm	NE-1700-40



**Martin**

width	20 cm/8"
6.5 mm	NE-1703-06
9.5 mm	NE-1703-09
13 mm	NE-1703-13
16 mm	NE-1703-16
19 mm	NE-1703-19
25 mm	NE-1703-25



**Fergusson**

Ø mm	11 cm/4.4"	13 cm/5.2"	16 cm/6.4"	20 cm/8"
1.5	NE-2700-15	NE-2701-15	NE-2702-15	NE-2703-15
2.0	NE-2700-20	NE-2701-20	NE-2702-20	NE-2703-20
2.5	NE-2700-25	NE-2701-25	NE-2702-25	NE-2703-25
3.0	NE-2700-30	NE-2701-30	NE-2702-30	NE-2703-30
4.0	NE-2700-40	NE-2701-40	NE-2702-40	NE-2703-40
5.0	NE-2700-50	NE-2701-50	NE-2702-50	NE-2703-50



**Lempert**

Ø mm	20 cm/8"
2	NE-2803-02
3	NE-2803-03



Ø mm	13 cm/5.2"	15 cm/6"	18 cm/7.2"	22 cm/8.8"
1.5	NE-2806-13	NE-2806-15	NE-2806-18	NE-2806-22
2.0	NE-2807-13	NE-2807-15	NE-2807-18	NE-2807-22
2.5	NE-2808-13	NE-2808-15	NE-2808-18	NE-2808-22
3.5	NE-2809-13	NE-2809-15	NE-2809-18	NE-2809-22

**Yarargil**



**Poppen**

charr 19 cm/7.6"

6	NE-2809-06
8	NE-2809-08
10	NE-2809-10
12	NE-2809-12



**Adson**

∅ mm 21 cm/8.4"

4	NE-2810-04N
---	-------------



**Adson**

∅ mm 14 cm/5.6" 21 cm/8.4"

3	NE-2900-14
4	NE-2900-21



**Frazier**

∅ mm 24 cm/9.6"

3.3	NE-2900-24
-----	------------



Insulated

4 mm

**Fergusson**

18 cm/7.2"  
NE-2901-04



**Frazier**

19 cm/7.6"

charr.	30°	75°	
6	NE-2905-06	NE-2907-06	
7	NE-2905-07	NE-2907-07	NE-2909-07
8	NE-2905-08	NE-2907-08	
9	NE-2905-09	NE-2907-09	NE-2909-09
10	NE-2905-10	NE-2907-10	
11	NE-2905-11	NE-2907-11	NE-2909-11
12	NE-2905-12	NE-2907-12	
15	NE-2905-15	NE-2907-15	

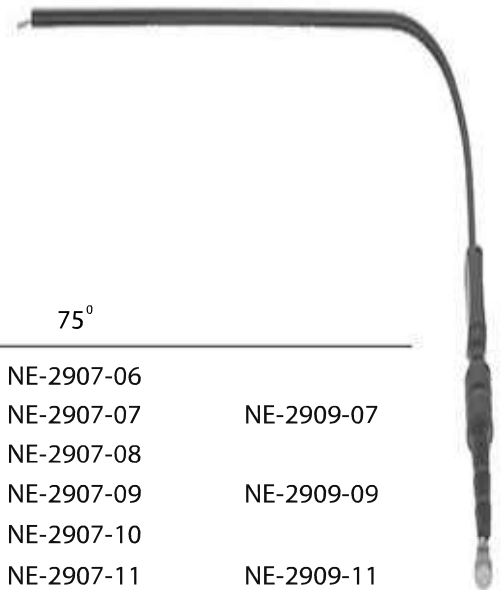

**Frazier**

19 cm/7.6"

Insulated

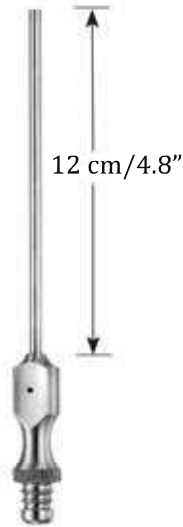

**Frazier**

charr	mm	
6	2.0	NE-2902-06N
8	2.7	NE-2902-08N
9	2.9	_____
10	3.3	NE-2902-10N
12	4.0	NE-2902-12N

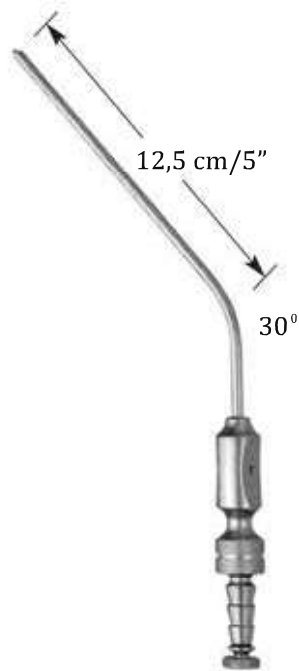

**Frazier**

NE-2903-06N
NE-2903-08N
NE-2903-09N
NE-2903-10N
NE-2903-12N

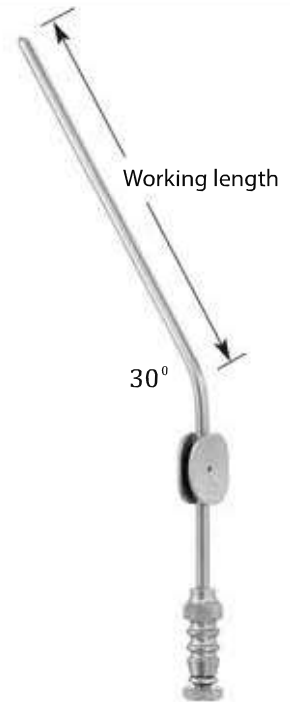

12,5 cm/5" 18 cm/7.2"

NE-2906-06N	NE-2906-16N
NE-2906-08N	NE-2906-18N
_____	_____
NE-2906-10N	NE-2906-30N
NE-2906-12N	NE-2906-32N



18 cm/7.2"

NE-2904-05N



**Luer**

mm	
4.5	NE-3007-45N
5.5	NE-3007-55N



**Yankauer**

mm	
2.0	AN-1409-27
4.8	AN-1408-27



**Magill**

mm	
3.0	AN-1505-30
3.5	AN-1505-35
4.0	AN-1505-40



**Frazier**

∅ mm 12 cm/4.8"

2.0	NE-2908-08
2.5	NE-2908-10
3.0	NE-2908-12



∅ mm 7 cm/2.8"

2.0	NE-3000-20
2.5	NE-3000-25



**Jefferson**

L ∅ 1.7 mm

8 cm/3.2"	NE-3001-08
10 cm/4"	NE-3001-10



**Cone**

charr. 9 cm/3.6"

12	NE-3002-12
13	NE-3002-13
14	NE-3002-14
15	NE-3002-15
16	NE-3002-16
17	NE-3002-17
18	NE-3002-18



**Dandy**

∅ mm 9,5 cm/3.8"

2	NE-3003-20
---	------------



**Cushing-Carins**

∅ mm 9,5 cm/3.8"

2.3	NE-3004-23
2.6	NE-3004-26

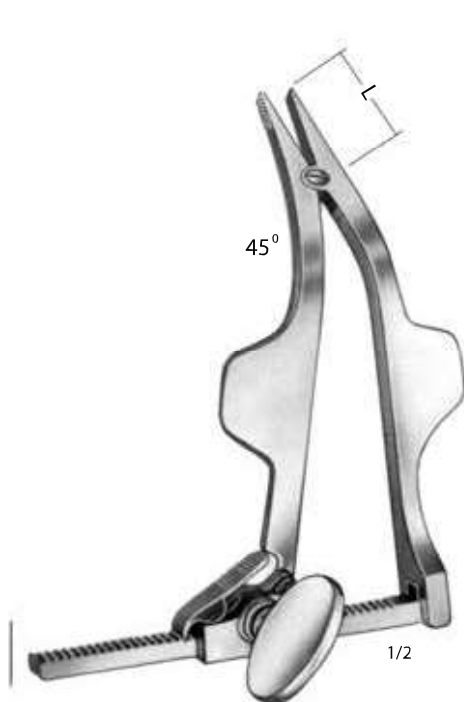

**Cloward**  
15 cm/6"  
NE-4002-15



**Cloward**  
17 cm/6.8"  
NE-4001-16

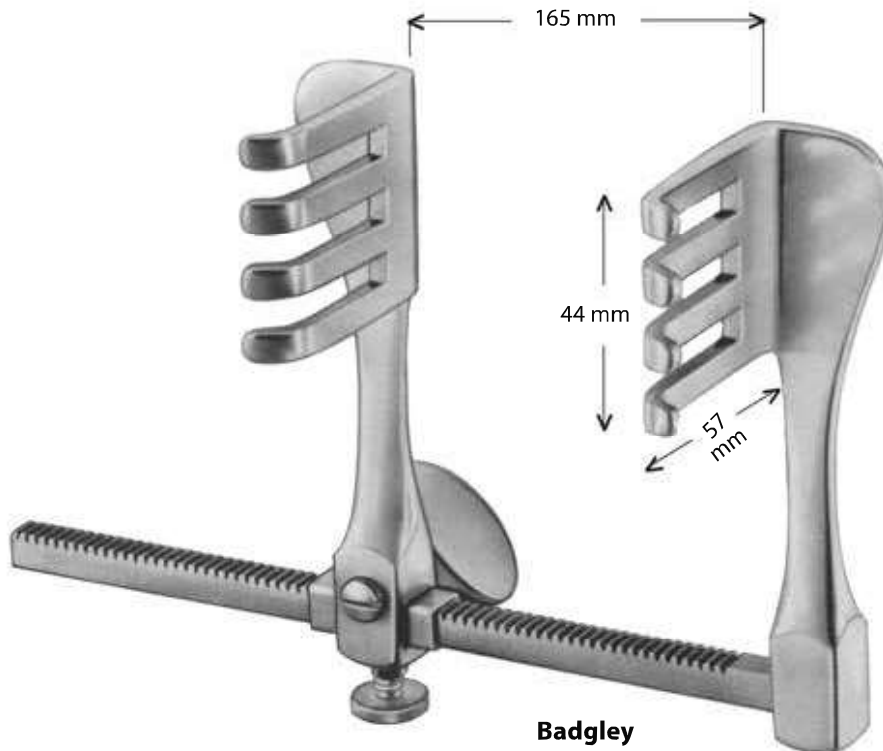

**Badgley**  
16 cm/6.4"  
TX-2602-16



2/3

**Inge (Baby-Inge)**

16 cm/6.4"

NE-4005-17

Blade opening 38 mm/1 1/2"



Serrated jaws

1/2

28 cm/11.2"

NE-4005-27

Blade opening 75 mm/3"

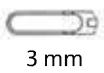
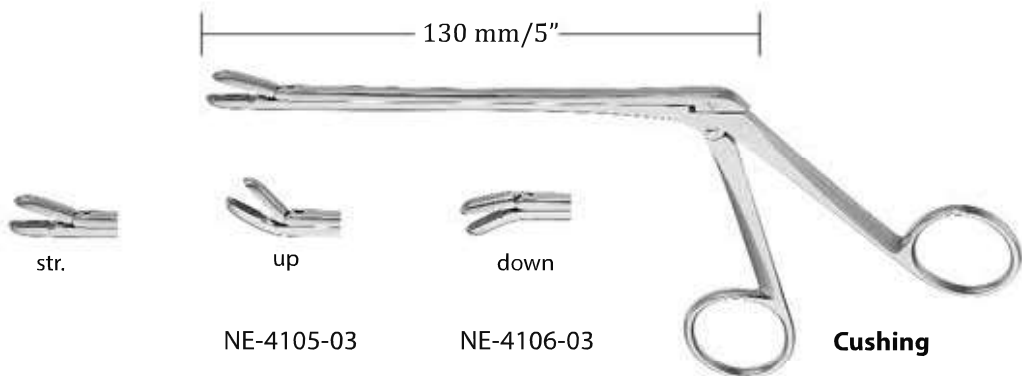
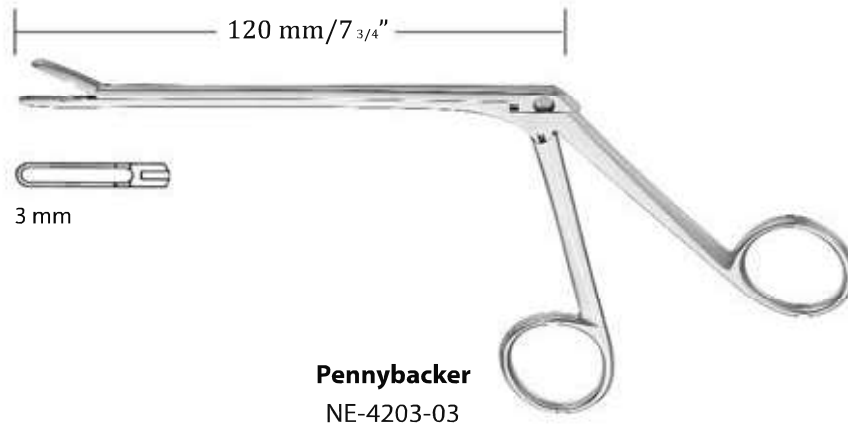

NE-4105-03

NE-4106-03

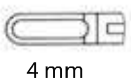

NE-4104-04

NE-4105-04

NE-4106-04

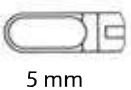

NE-4104-05

NE-4105-05

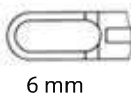

NE-4104-06



**Cushing**



2.0 mm

12 cm/4.8"

15 cm/6"

18 cm/7.2"



NE-4200-01

NE-4201-01

NE-4202-01



NE-4200-02

NE-4201-02

NE-4202-02



NE-4200-03

NE-4201-03

NE-4202-03

**Love-Greunwald**



3.0 mm

12 cm/4.8"

15 cm/6"

18 cm/7.2"



NE-4300-01

NE-4301-01

NE-4302-01



NE-4300-02

NE-4301-02

NE-4302-02



NE-4300-03

NE-4301-03

NE-4302-03

**Spurling**



4.0 mm

12 cm/4.8"

15 cm/6"

18 cm/7.2"



NE-4400-01

NE-4401-01

NE-4402-01



NE-4400-02

NE-4401-02

NE-4402-02



NE-4400-03

NE-4401-03

NE-4402-03

## Bandscheiben Rongeur Intervertebral Disc Rongeurs Disque intervertébral Rongeurs

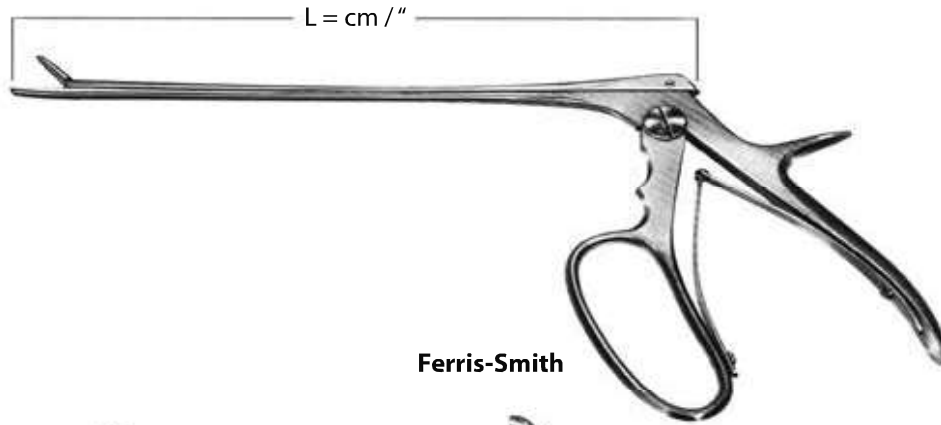

**Ferris-Smith**

Jaw width	16 cm/6.4"	18 cm/7.2"	16 cm/6.4"	18 cm/7.2"	16 cm/6.4"	18 cm/7.2"
2 mm		NE-4501-01		NE-4501-02		NE-4501-03
3 mm	NE-4500-01	NE-4502-01	NE-4500-02	NE-4502-02	NE-4500-03	NE-4502-03
4mm		NE-4503-01		NE-4503-02		NE-4503-03

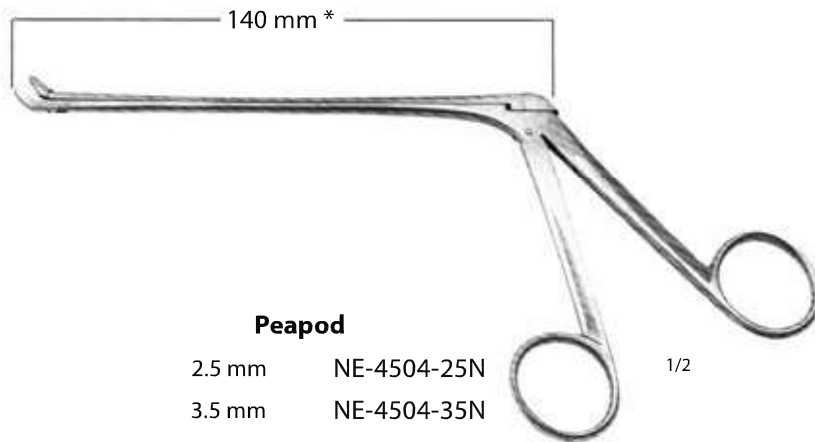

**Peapod**

2.5 mm NE-4504-25N  
3.5 mm NE-4504-35N

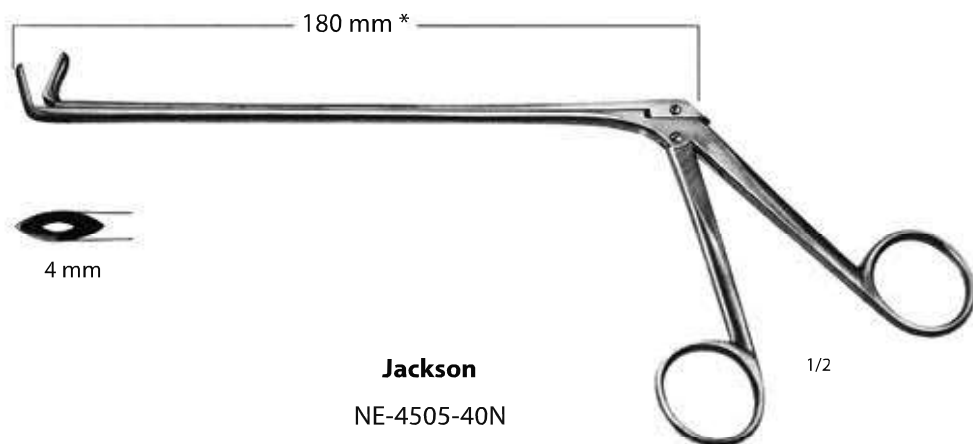

1/2



**Jackson**  
NE-4505-40N

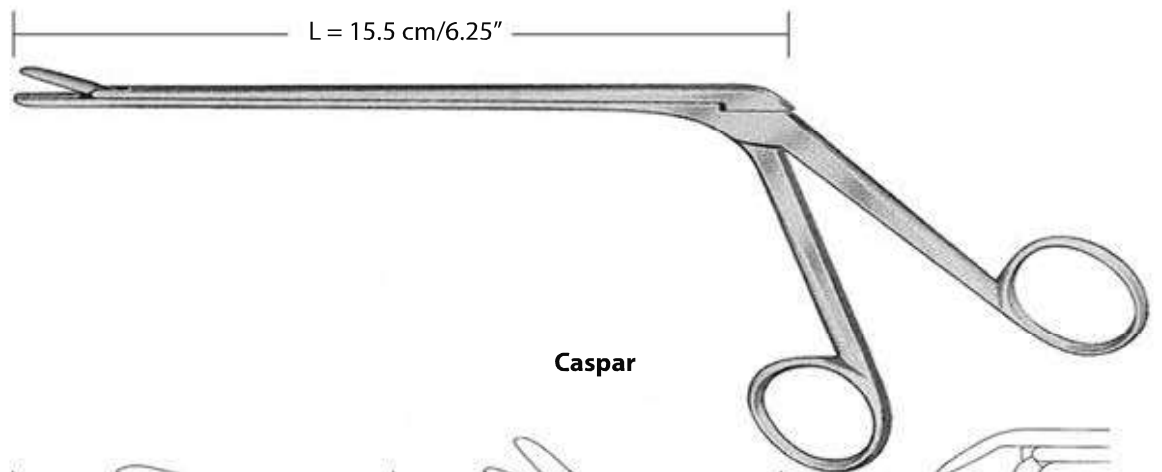
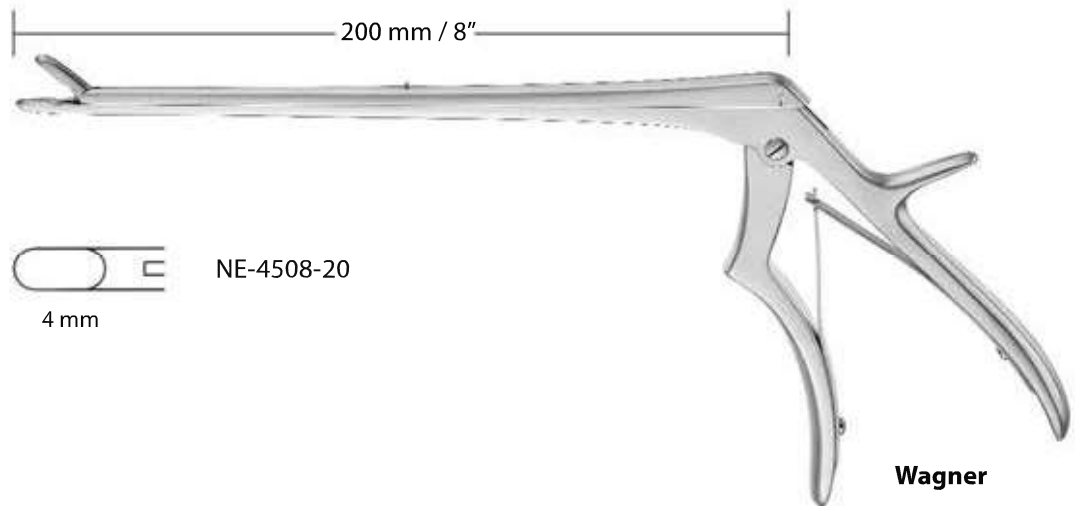
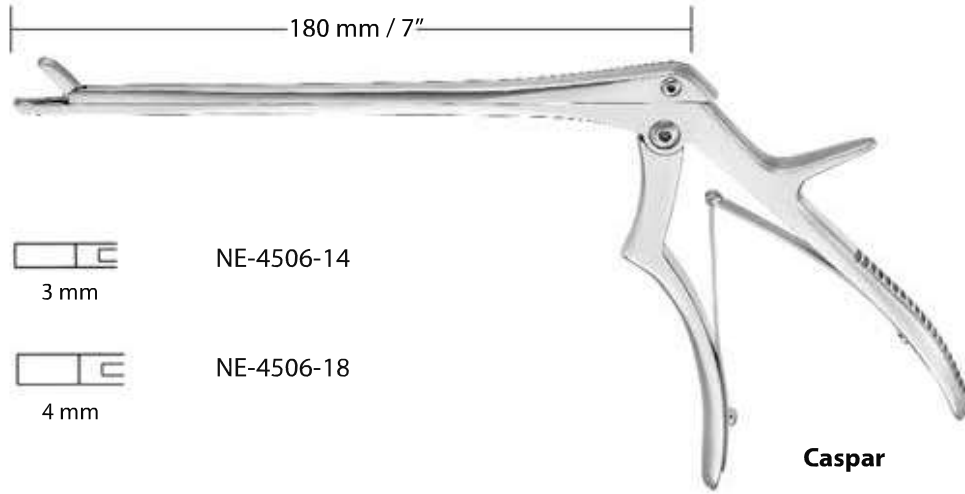



1/2

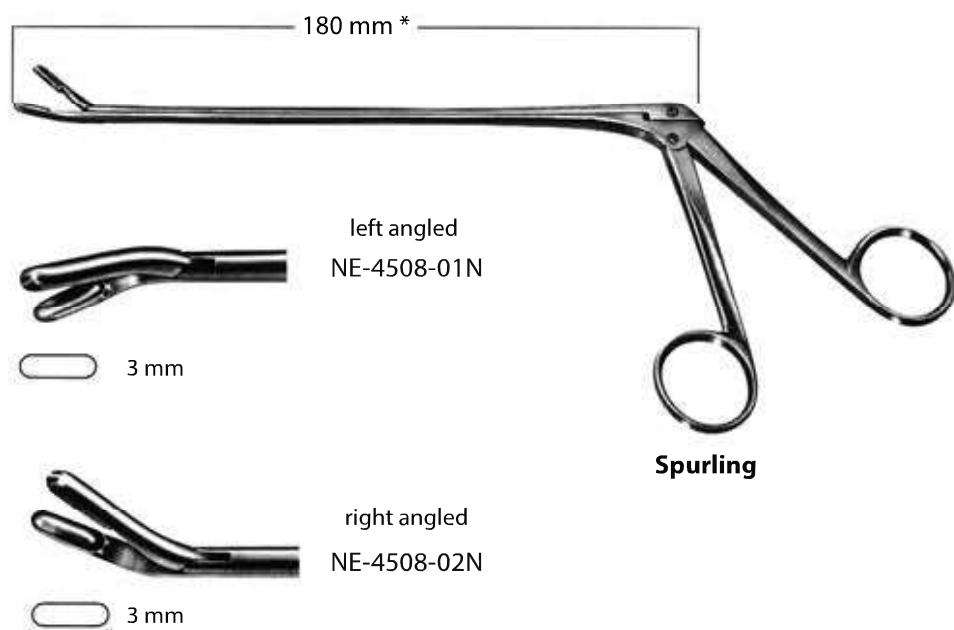
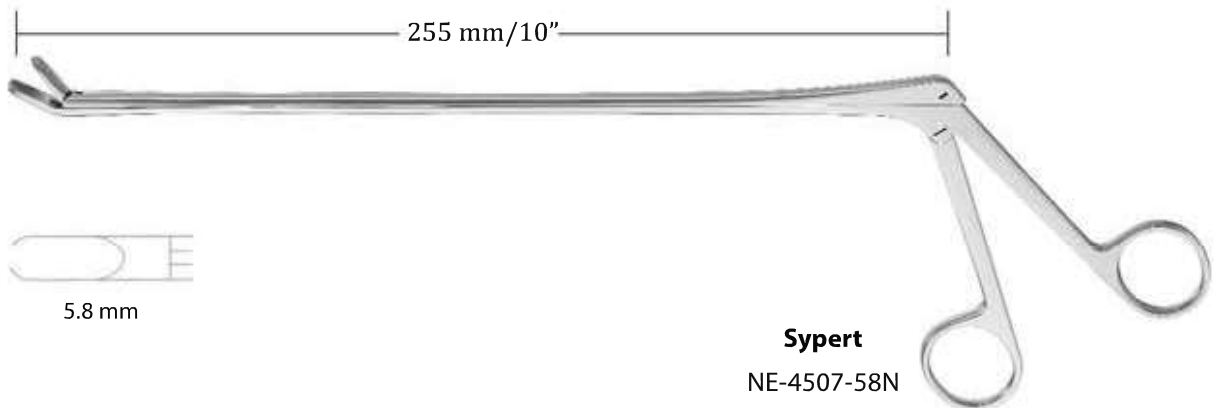
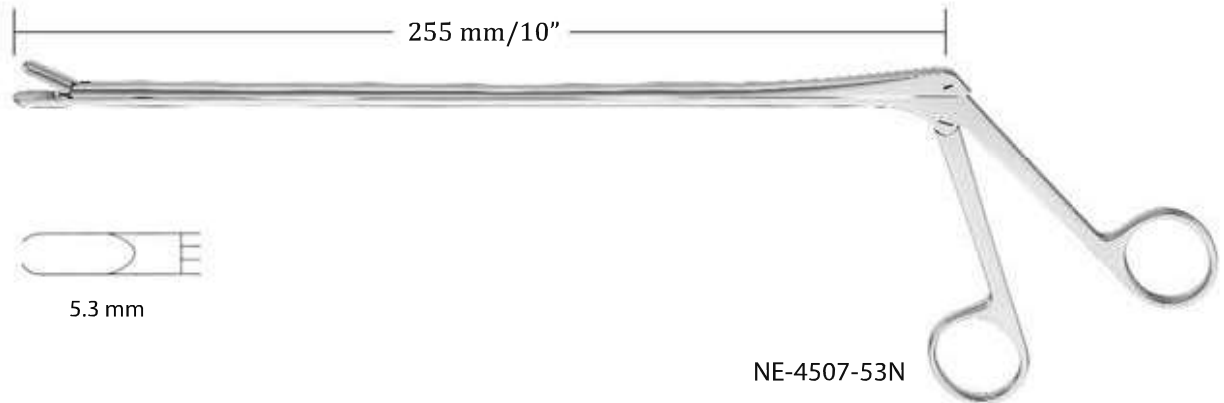

Jaw width			
2 mm	NE-4700-02	NE-4701-02	NE-4703-02
3 mm	NE-4700-03	NE-4701-03	NE-4703-03
4 mm	NE-4700-04	NE-4701-04	NE-4703-04
5 mm	NE-4700-05		





- |                 |            |   |                     |
|-----------------|------------|---|---------------------|
| <b>Oldberg</b>  | NE-4405-70 |  | 7 mm, 180 mm long   |
| <b>Yasargil</b> | NE-4407-22 |  | 2.2 mm, 190 mm long |
| <b>Yasargil</b> | NE-4407-35 |  | 3.5 mm, 190 mm long |
| <b>Landolt</b>  | NE-4408-90 |  | 9 mm, 200 mm long   |

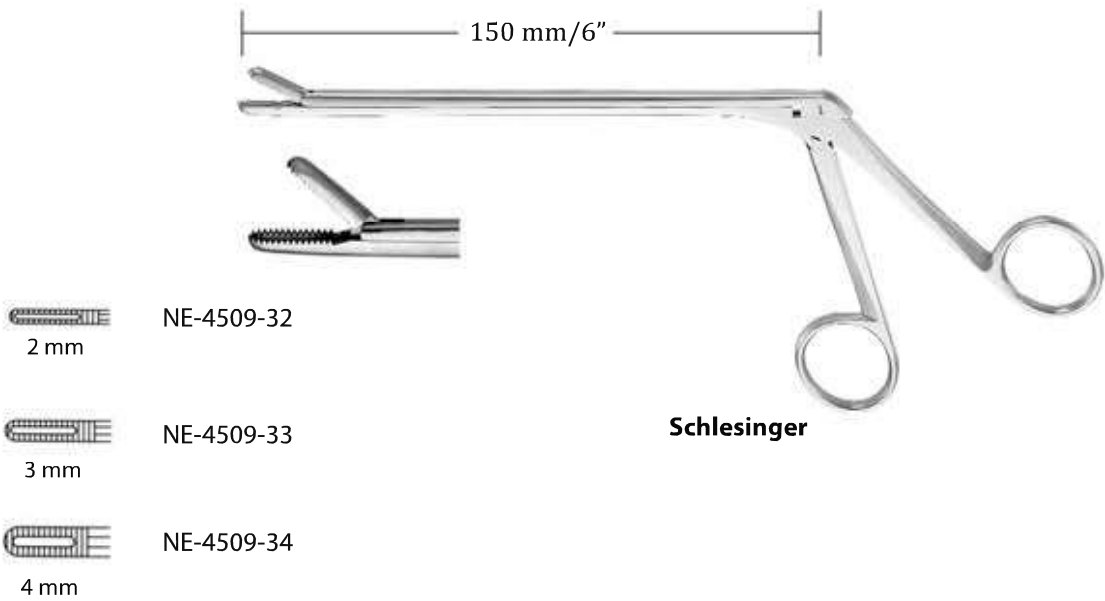
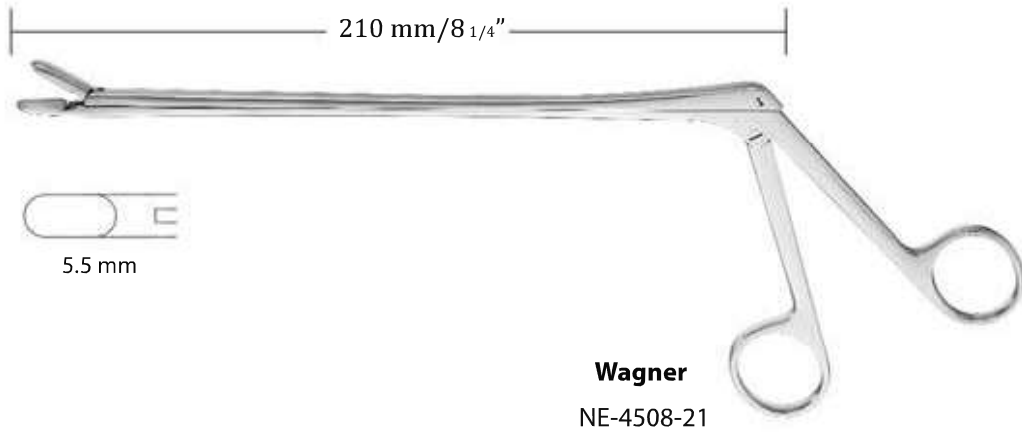

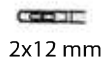
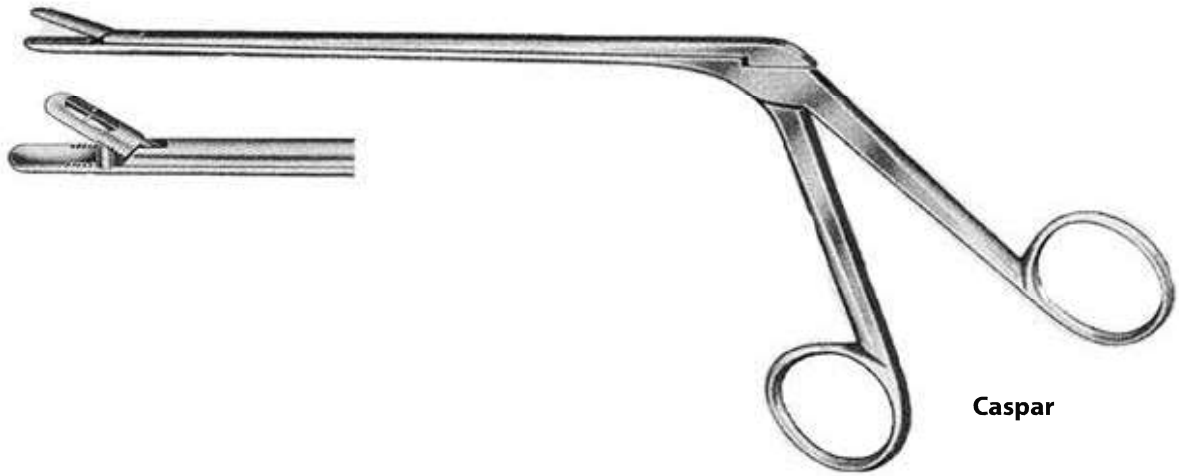

14 cm/5.6"	NE-4600-20
16 cm/6.4"	NE-4604-20
18,5 cm/7.4"	NE-4608-20

NE-4601-20
NE-4605-20

NE-4603-20
NE-4607-20

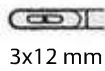

14 cm/5.6"	NE-4600-30
16 cm/6.4"	NE-4604-30
18,5 cm/7.4"	NE-4608-30

NE-4601-30
NE-4605-30
NE-4609-30

NE-4603-30
NE-4607-30
NE-4615-30



14 cm/5.6"	NE-4600-40
16 cm/6.4"	NE-4604-40
18,5 cm/7.4"	NE-4608-40

NE-4601-40
NE-4605-40
NE-4609-40

NE-4603-40
NE-4607-40
NE-4615-40



14 cm/5.6"	NE-4600-50
16 cm/6.4"	NE-4604-50
18,5 cm/7.4"	NE-4608-50

NE-4601-50
NE-4605-50
NE-4609-50

NE-4607-50
NE-4615-50



14 cm/5.6"	NE-4600-60
16 cm/6.4"	NE-4604-60
18,5 cm/7.4"	NE-4608-60



**Kerrison**

Up 90



mm	mm	
18 cm/7.2"	1	NE-5100-01
20 cm/8"	1	NE-5110-01
23 cm/9.2"	1	NE-5120-01
25 cm/10"	1	NE-5130-01
27 cm/10.8"	1	NE-5140-01



mm	mm	
18 cm/7.2"	2	NE-5100-02
20 cm/8"	2	NE-5110-02
23 cm/9.2"	2	NE-5120-02
25 cm/10"	2	NE-5130-02
27 cm/10.8"	2	NE-5140-02



mm	mm	
18 cm/7.2"	3	NE-5100-03
20 cm/8"	3	NE-5110-03
23 cm/9.2"	3	NE-5120-03
25 cm/10"	3	NE-5130-03
27 cm/10.8"	3	NE-5140-03

mm	mm	
18 cm/7.2"	4	NE-5100-04
20 cm/8"	4	NE-5110-04
23 cm/9.2"	4	NE-5120-04
25 cm/10"	4	NE-5130-04
27 cm/10.8"	4	NE-5140-04

mm	mm	
18 cm/7.2"	5	NE-5100-05
20 cm/8"	5	NE-5110-05
23 cm/9.2"	5	NE-5120-05
25 cm/10"	5	NE-5130-05
27 cm/10.8"	5	NE-5150-05

mm	mm	
18 cm/7.2"	6	NE-5100-06
20 cm/8"	6	NE-5110-06
23 cm/9.2"	6	NE-5120-06
25 cm/10"	6	NE-5130-06
27 cm/10.8"	6	NE-5160-06

Down 90



mm	mm	
18 cm/7.2"	1	NE-5101-01
20 cm/8"	1	NE-5111-01
23 cm/9.2"	1	NE-5121-01
25 cm/10"	1	NE-5131-01
27 cm/10.8"	1	NE-5141-01

mm	mm	
18 cm/7.2"	2	NE-5101-02
20 cm/8"	2	NE-5111-02
23 cm/9.2"	2	NE-5121-02
25 cm/10"	2	NE-5131-02
27 cm/10.8"	2	NE-5141-02

mm	mm	
18 cm/7.2"	3	NE-5101-03
20 cm/8"	3	NE-5111-03
23 cm/9.2"	3	NE-5121-03
25 cm/10"	3	NE-5131-03
27 cm/10.8"	3	NE-5141-03

mm	mm	
18 cm/7.2"	4	NE-5101-04
20 cm/8"	4	NE-5111-04
23 cm/9.2"	4	NE-5121-04
25 cm/10"	4	NE-5131-04
27 cm/10.8"	4	NE-5141-04

mm	mm	
18 cm/7.2"	5	NE-5101-05
20 cm/8"	5	NE-5111-05
23 cm/9.2"	5	NE-5121-05
25 cm/10"	5	NE-5131-05
27 cm/10.8"	5	NE-5141-05

mm	mm	
18 cm/7.2"	6	NE-5101-06
20 cm/8"	6	NE-5111-06
23 cm/9.2"	6	NE-5121-06
25 cm/10"	6	NE-5131-06
27 cm/10.8"	6	NE-5141-06

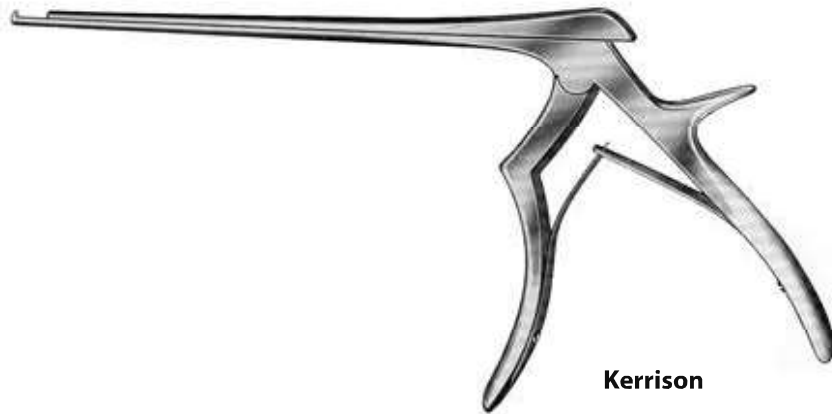

Up 40



mm			
18 cm/7.2"	NE-5102-01	1	
20 cm/8"	NE-5112-01	1	
23 cm/9.2"	NE-5122-01	1	
25 cm/10"	NE-5132-01	1	
27 cm/10.8"	NE-5142-01	1	



mm			
18 cm/7.2"	NE-5102-02	2	
20 cm/8"	NE-5112-02	2	
23 cm/9.2"	NE-5122-02	2	
25 cm/10"	NE-5132-02	2	
27 cm/10.8"	NE-5142-02	2	



mm			
18 cm/7.2"	NE-5102-03	3	
20 cm/8"	NE-5112-03	3	
23 cm/9.2"	NE-5122-03	3	
25 cm/10"	NE-5132-03	3	
27 cm/10.8"	NE-5142-03	3	

mm			
18 cm/7.2"	NE-5102-04	4	
20 cm/8"	NE-5112-04	4	
23 cm/9.2"	NE-5122-04	4	
25 cm/10"	NE-5132-04	4	
27 cm/10.8"	NE-5142-04	4	

mm			
18 cm/7.2"	NE-5102-05	5	
20 cm/8"	NE-5112-05	5	
23 cm/9.2"	NE-5122-05	5	
25 cm/10"	NE-5132-05	5	
27 cm/10.8"	NE-5152-05	5	

mm			
18 cm/7.2"	NE-5102-06	6	
20 cm/8"	NE-5112-06	6	
23 cm/9.2"	NE-5122-06	6	
25 cm/10"	NE-5132-06	6	
27 cm/10.8"	NE-5162-06	6	

Down 40



mm			
18 cm/7.2"	NE-5103-01	1	
20 cm/8"	NE-5113-01	1	
23 cm/9.2"	NE-5123-01	1	
25 cm/10"	NE-5133-01	1	
27 cm/10.8"	NE-5143-01	1	

mm			
18 cm/7.2"	NE-5103-02	2	
20 cm/8"	NE-5113-02	2	
23 cm/9.2"	NE-5123-02	2	
25 cm/10"	NE-5133-02	2	
27 cm/10.8"	NE-5143-02	2	



mm			
18 cm/7.2"	NE-5103-03	3	
20 cm/8"	NE-5113-03	3	
23 cm/9.2"	NE-5123-03	3	
25 cm/10"	NE-5133-03	3	
27 cm/10.8"	NE-5143-03	3	



mm			
18 cm/7.2"	NE-5103-04	4	
20 cm/8"	NE-5113-04	4	
23 cm/9.2"	NE-5123-04	4	
25 cm/10"	NE-5133-04	4	
27 cm/10.8"	NE-5143-04	4	

mm			
18 cm/7.2"	NE-5103-05	5	
20 cm/8"	NE-5113-05	5	
23 cm/9.2"	NE-5123-05	5	
25 cm/10"	NE-5133-05	5	
27 cm/10.8"	NE-5143-05	5	

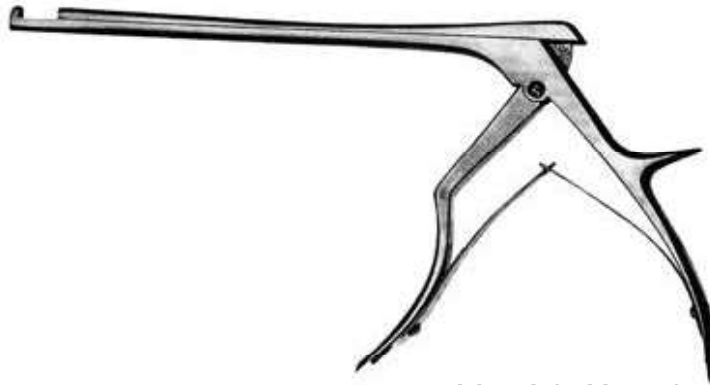
mm			
18 cm/7.2"	NE-5103-06	6	
20 cm/8"	NE-5113-06	6	
23 cm/9.2"	NE-5123-06	6	
25 cm/10"	NE-5133-06	6	
27 cm/10.8"	NE-5143-06	6	

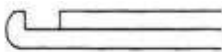
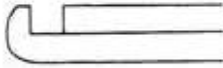

Calclough (Schlesing)

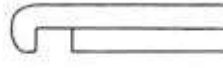
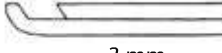
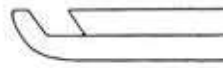
		
	3 mm	5 mm
15 cm/6"	NE-5200-03	NE-5200-05
20 cm/8"	NE-5202-03	NE-5202-05
		
	3 mm	5 mm
15 cm/6"	NE-5204-03	NE-5204-05
20 cm/8"	NE-5206-03	NE-5206-05
		
	3 mm	5 mm
15 cm/6"	NE-5207-03	NE-5207-05
20 cm/8"	NE-5209-03	NE-5209-05

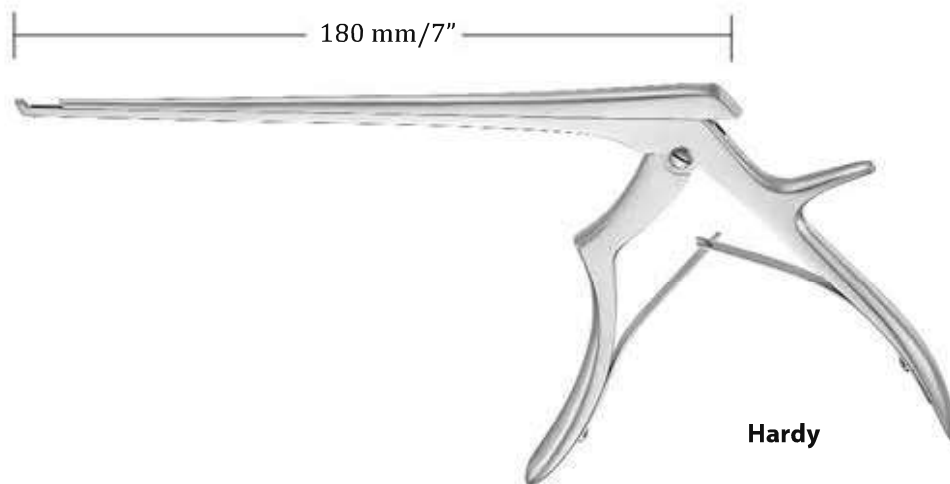
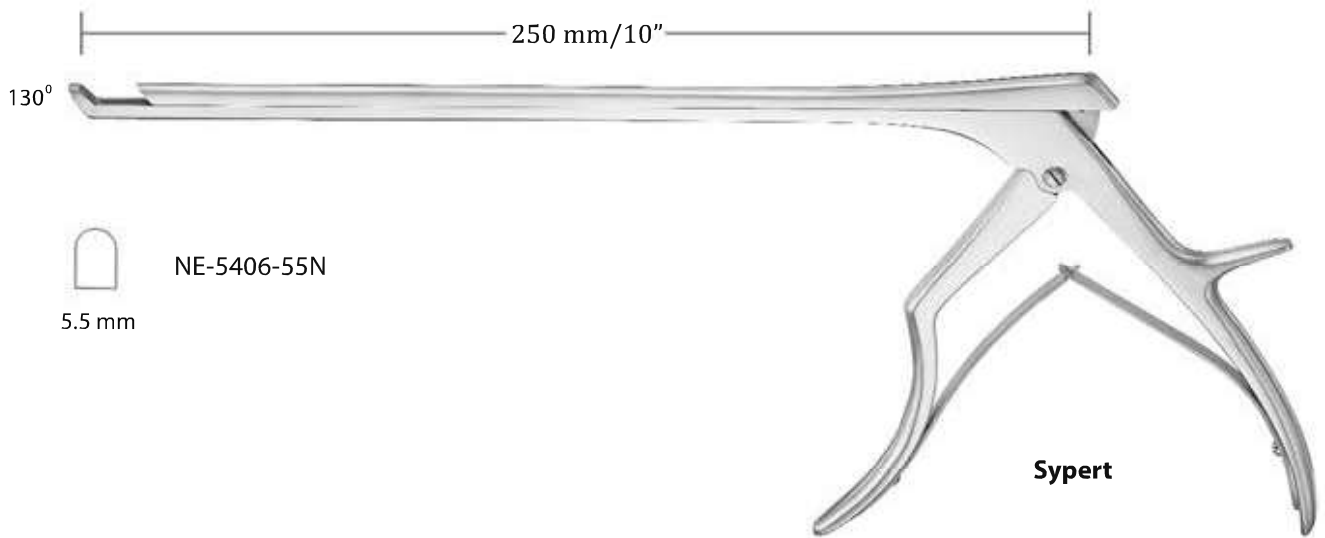
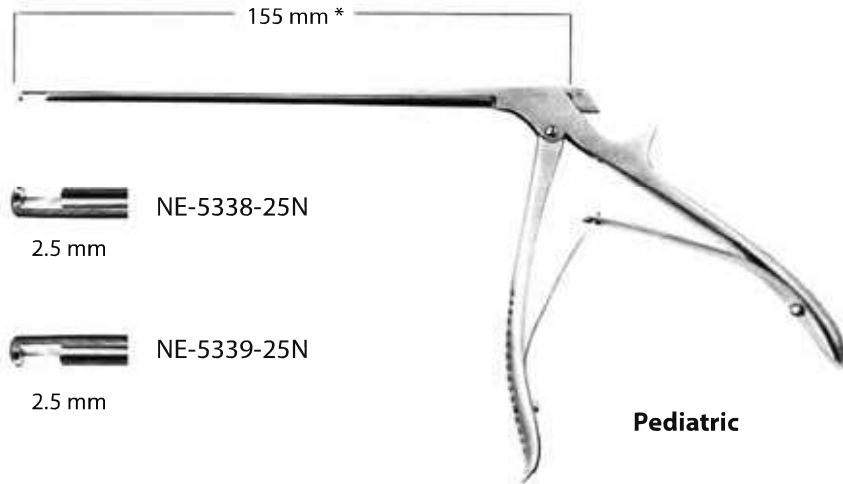

	up 40°	up 90°	down 40°	down 90°
1 mm	NE-5504-01N			
2 mm	NE-5500-02N	NE-5501-02N	NE-5503-02N	NE-5502-02N

Buttoned Probes



**Jacobson**

18,5 cm/7.4"

NE-0606-19N NE-0606-20N

Vessel Spreader



**Biemer**

NE-0606-10N

Vessel Dilator



12,5 cm/5"

0.5 mm

NE-0606-16N

1 mm

NE-0606-17N

1.5 mm

NE-0606-18N

Vessel Knives



**Koss**

NE-8412-19N

up ward

NE-8413-19

down ward



**Koss**

18,5 cm/7.4"

NE-8415-19

up ward

NE-8416-19N

down ward



**Koss**

NE-0605-51N

up ward

NE-0605-52N

down ward

Arachnoid Knives



**Yasargil**

NE-8419-19

down ward

NE-8418-19N

up ward

Tumer Knives



1 mm

NE-0705-10N



1.5 mm

NE-0705-11N



2 mm

NE-0705-12N



2.5 mm

NE-0705-13N



3 mm

NE-0705-14N



3.5 mm

NE-0705-15N



4 mm

NE-0705-16N



4.5 mm

NE-0705-18N

**Samii**  
 23 cm/9.2"



1.5 mm

NE-0706-01N



3 mm

NE-0706-02N



4.5 mm

NE-0706-03N



6 mm

NE-0706-04N

Lancet Knives



1.8 mm

NE-0707-18N



2.5 mm

NE-0707-25N

**Samii**  
 23 cm/9.2"

Tumer Forks



**Yasargil**  
20 cm/8"



5 mm  
NE-0709-05N



8 mm  
NE-0709-08N



**Okonek-Yasargil**  
23 cm/9.2"



3 mm  
NE-1704-03N



4 mm  
NE-1704-04N



5 mm  
NE-1704-05N



8 mm  
NE-1708-05N

Dissectors

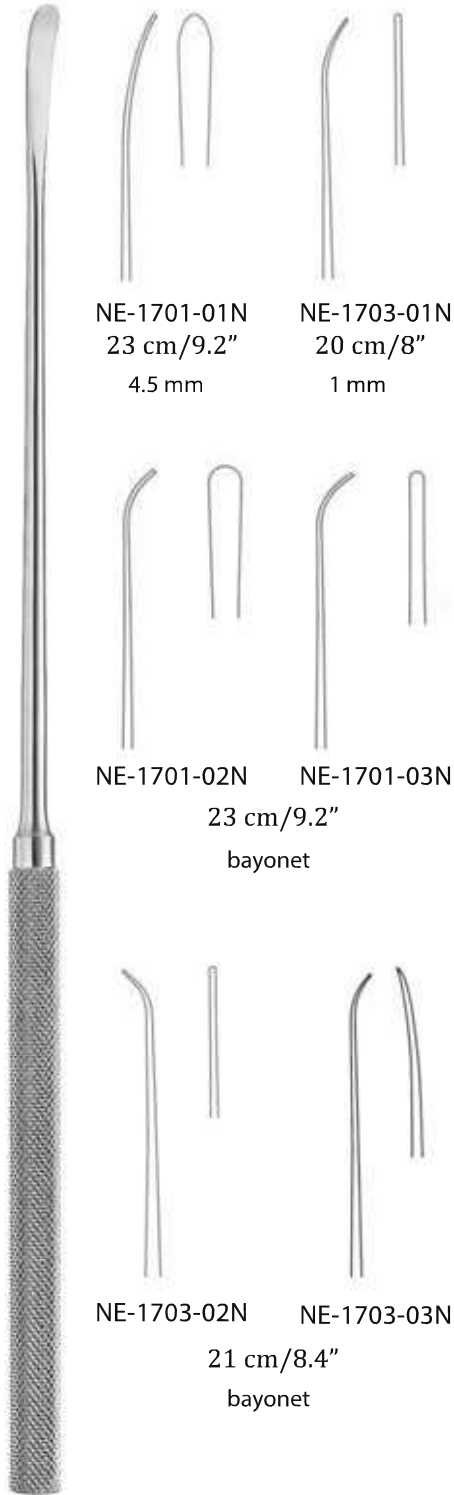

Caspar

Tissue Claws



18,5 cm/7.4"

Dura Hooks

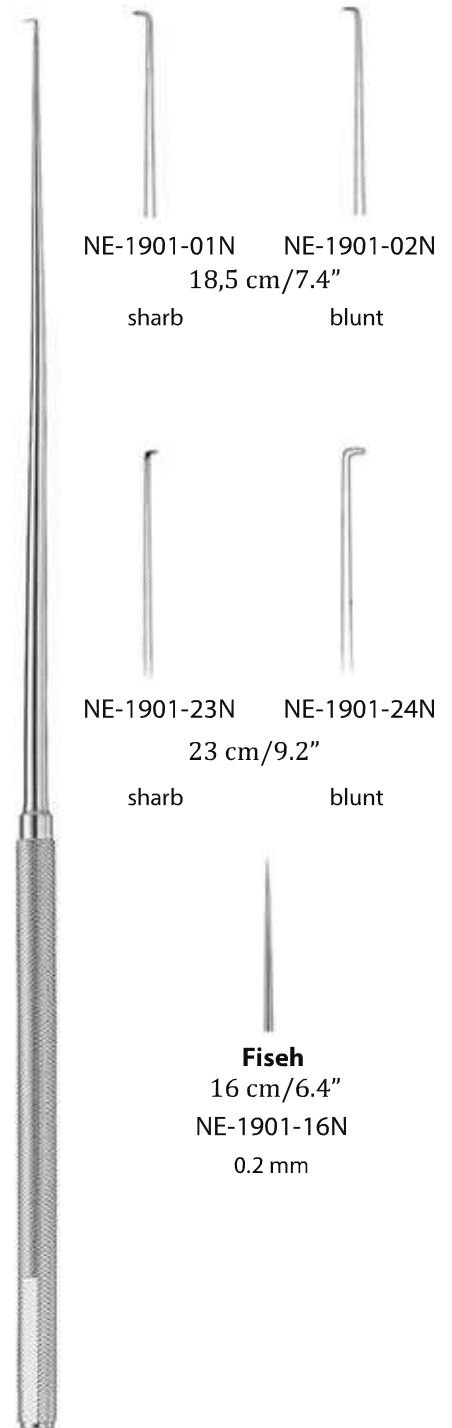

Knot tier and ligature pusher

interchangeable  
vessel knife



**Jacobson**  
9.5 cm/3.8"  
NE-1702-01N

interchangeable  
hook



NE-1702-02N  
9.5 cm/3.8"

NE-1702-10N  
10.5 cm/4.2"

Handle with chuck

**Jacobson**  
NE-1702-19N



**Caspar**  
NE-1701-04N

23 cm/9.2"

Ligature guide and carrier



Fig. 1  
NE-8371-01

Fig. 2  
NE-8371-02



Fig. 3  
NE-8371-03

Fig. 4  
NE-8371-04



**Yasargil**  
18.5 cm/7.4"

### round dissectors

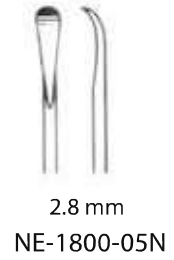
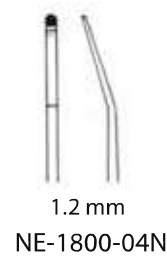
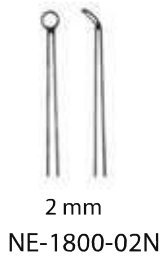
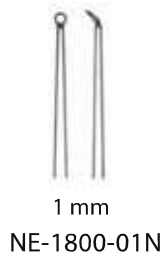

### elevators

### spatula dissectors

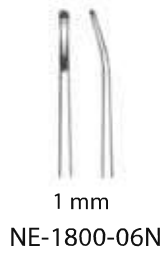

### Hooks

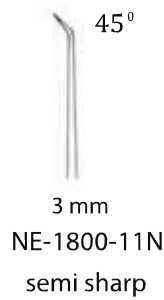
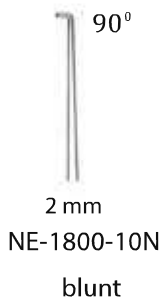

### Needle



### probes



### oval currettes

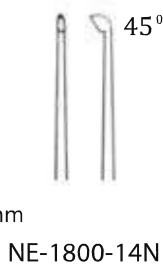
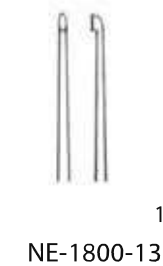

**Rhoton**  
19 cm/7.6"

### Exploration and coagulation hooks



NE-8365-01



NE-8365-02



NE-8365-03



NE-8365-04

**Caspar**

24,5 cm/9.8"

### Nerve and vessel hooks



NE-8373-01



NE-8373-02



NE-8373-03



NE-8373-04

**Krayenbuhl**

18,5 cm/7.4"

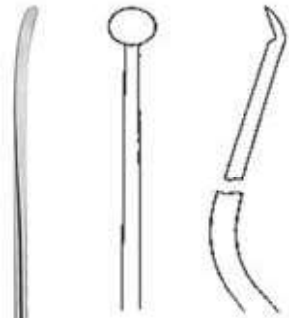

NE-8375-01  
23 cm/9.2"



2.5 mm  
NE-8375-02



2.0 mm  
NE-8375-03



2.0 mm  
NE-8375-04

**Yasargil**  
18,5 cm/7.4"



NE-8377-01



NE-8377-02



NE-8377-03



NE-8377-04



NE-8377-05

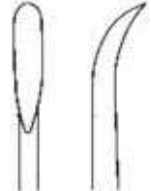

NE-8377-06



NE-8377-07

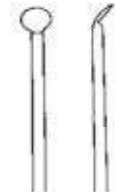













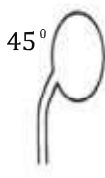



NE-8377-08

plate shape

**Yasargil**  
18,5 cm/7.4"







**Ray**  
19 cm/7.6"

				
	45°	90°	45°	90°
				
	3 mm	3 mm	3 mm	3 mm
	NE-8101-03	NE-8102-03	NE-8103-03	NE-8104-03
				
	4 mm	4 mm	4 mm	4 mm
	NE-8101-04	NE-8102-04	NE-8103-04	NE-8104-04
				
	5 mm	5 mm	5 mm	5 mm
	NE-8101-05	NE-8102-05	NE-8103-05	NE-8104-05



**Ray**  
19 cm/7.6"  
4 mm

				
	NE-8390-45	NE-8390-90	NE-8391-45	NE-8391-90

Malleable Currettes



**Hardy**  
26 cm/10.4"



4 mm  
NE-8105-04

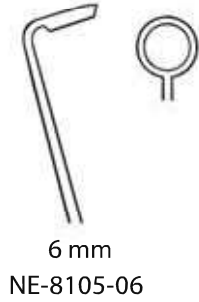

6 mm  
NE-8105-06



**Nicola**  
22 cm/8.8"

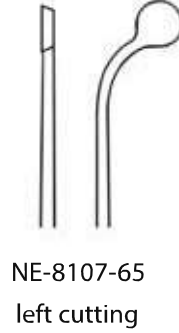

NE-8107-65  
left cutting



NE-8109-65  
right cutting



NE-8201-65



**Nicola**  
21,5 cm/8.6"  
NE-8203-00



3 mm NE-8204-03  
4 mm NE-8204-04  
6 mm NE-8204-06  
7 mm NE-8204-07  
8 mm NE-8204-08  
9 mm NE-8204-09

**Cone**  
23 cm/9.2"



3 mm NE-8205-03  
4 mm NE-8205-04  
6 mm NE-8205-06  
7 mm NE-8205-07  
8 mm NE-8205-08  
9 mm NE-8205-09



angled up

3 mm NE-8500-03  
5 mm NE-8500-05



angled down

NE-8501-03  
NE-8501-05

**Hardy**  
24 cm/9.6"



right cvd

NE-8502-03  
NE-8502-05



left cvd

NE-8503-03  
NE-8503-05



right

NE-8504-05

**Hardy**  
24 cm/9.6"  
5 mm



left

NE-8505-05

Malleable spoon



**Hardy**  
24 cm/9.6"  
NE-8506-24

### Trans-sphenoidal



**Cushing-Landolt**

NE-8001-70 70x15 mm  
NE-8001-90 90x15 mm  
NE-8002-10 110x15 mm



**Hardy**

NE-8005-70 70 mm  
NE-8005-90 80 mm  
NE-8005-10 90 mm



**Papavero-Caspar**

NE-8007-11 80x11 mm  
NE-8007-13 90x13 mm  
NE-8007-15 100x15 mm

### Lamina chisel



**Papavero**  
22 cm/8.8"  
NE-8003-22

### spreader for specula



**Landolt**  
21 cm/8.4"  
NE-8004-21

### Enucleators



**Hardy**  
24,5 cm/9.8"



NE-8302-24



NE-8303-24

blunt



NE-8306-24



NE-8307-24

sharp

### Implant fork



**Hardy**  
24,5 cm/9.8"



NE-8310-00

### Dissector



**Hardy-Fahebusch**



NE-8320-24



NE-8322-24

### Micro Dissectors



NE-8303-02  
angled up



NE-8304-02  
angled down

**Hardy**  
24 cm/9.6"  
2 mm

### Micro Mirror



**Hardy**  
23 cm/9.2"  
5 mm  
NE-8300-00



**Yasargil**  
21 cm/8.4"  
6 mm  
NE-8601-24

### Pituitary curettes



**Yasargil**  
23 cm/9.2"



NE-8385-23  
sharp



NE-8386-23  
sharp



**Yasargil**  
18,5 cm/7.4"  
NE-8387-18

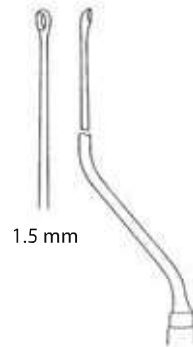

1.5 mm

malleable enucleator



NE-8342-26

blunt



NE-8343-26

blunt

malleable curette

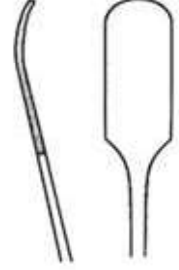

NE-8346-26

malleable spoon

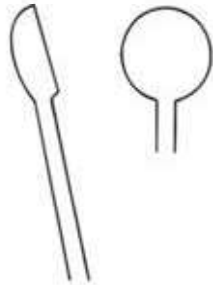

NE-8347-26

malleable hook



NE-8348-26

blunt

fork spatula



NE-8349-26

blunt



**Landolt**

26 cm/10.4"

malleable spoon



26 cm/10.4"



2 mm

NE-8350-26

**Fahlebusch**



2.5 mm

NE-8351-26



2.5 mm

**Landolt-Reulen**

NE-8355-25

Raspatory



2.2 mm

NE-8353-22

**Landolt-Reulen**



3.2 mm

NE-8353-32

Blunt Hook



2.2 mm

NE-8359-20

**Landolt-Reulen**

Dissector



1.7 mm

NE-8357-17

### Hypophysectomy Forceps



**Adson**  
23 cm/9.2"  
NE-2100-23



**Adson**  
23 cm/9.2"  
NE-2101-23



**Adson**  
23 cm/9.2"  
NE-2103-23



**Landolt**  
21,5 cm/8.6"  
NE-8705-22



**Hardy**  
21cm/8.4"  
NE-8706-21

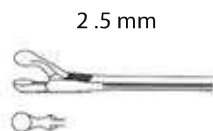
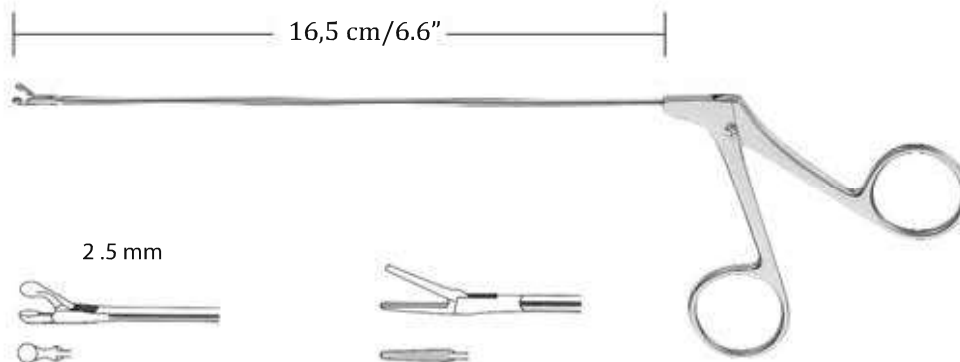

**Nicola**  
NE-8802-16  
scoop-shaped



**Yasargil-Nicola**  
NE-8806-16  
conical jaws

### Hypophysectomy Scissors

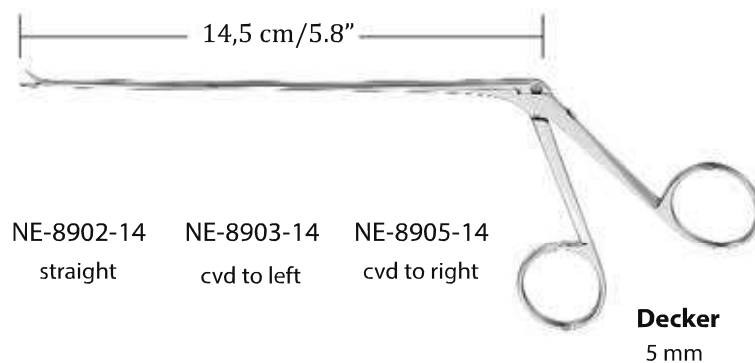
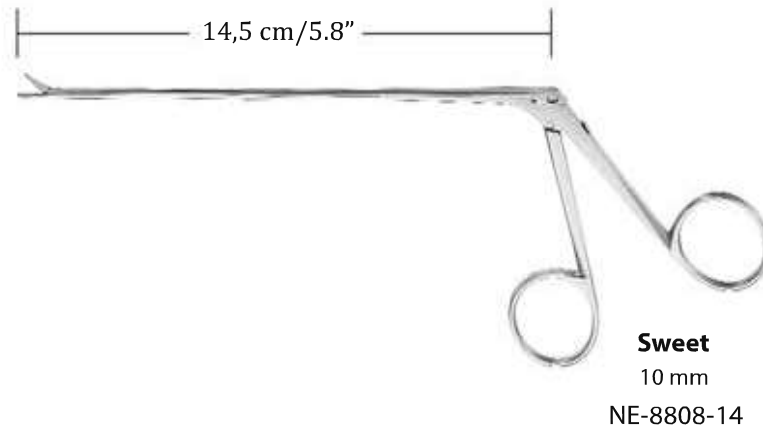
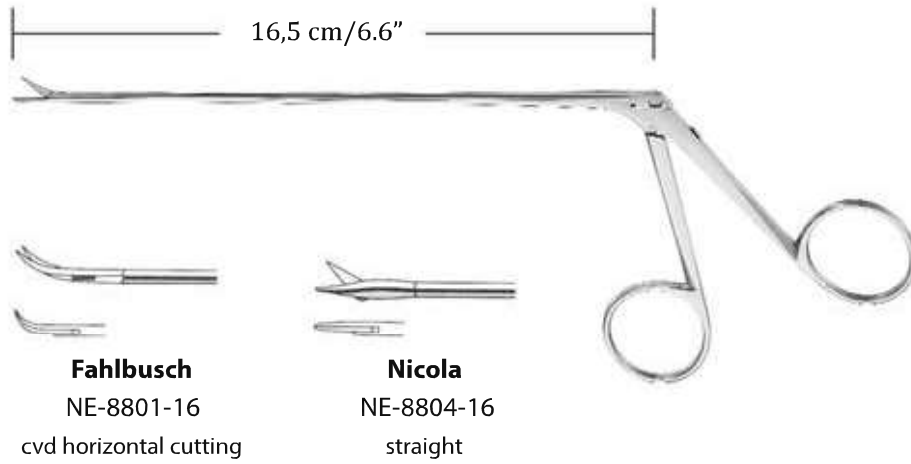



**Penfield**  
17.5 cm/6.8"  
NE-1601-01



**Penfield**  
19.5 cm/7.8"  
NE-1601-02



**Penfield**  
19.5 cm/7.8"  
NE-1601-03



**Penfield**  
21.5 cm/8.6"  
NE-1601-04



**Penfield**  
29 cm/11.5"  
NE-1601-05