

Gynakologie

Gynaecology

Gynécologie

GI

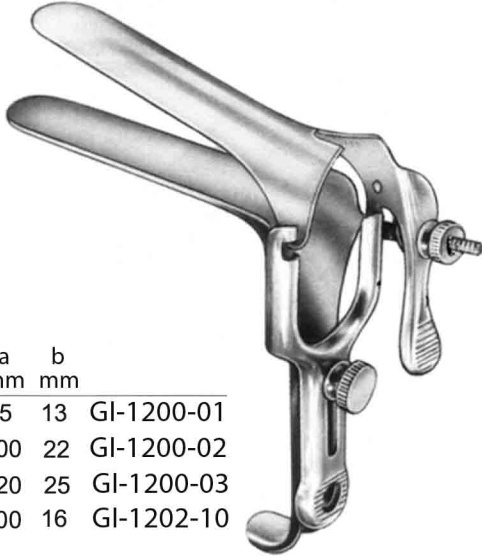
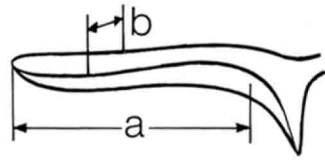

a	b	
mm	mm	
75	13	GI-1200-01
100	22	GI-1200-02
120	25	GI-1200-03
100	16	GI-1202-10

Pederson

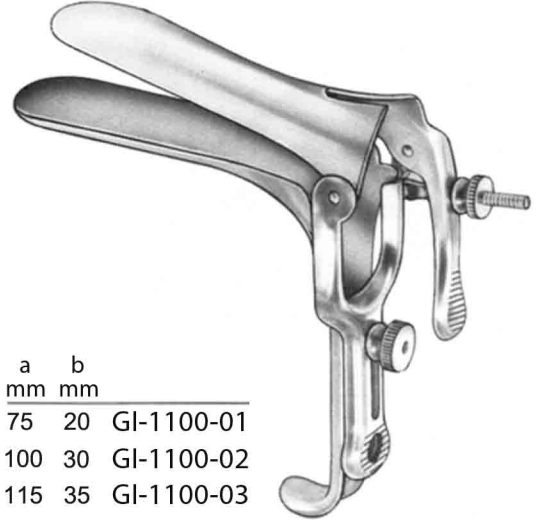

a	b	
mm	mm	
75	20	GI-1100-01
100	30	GI-1100-02
115	35	GI-1100-03

Graves

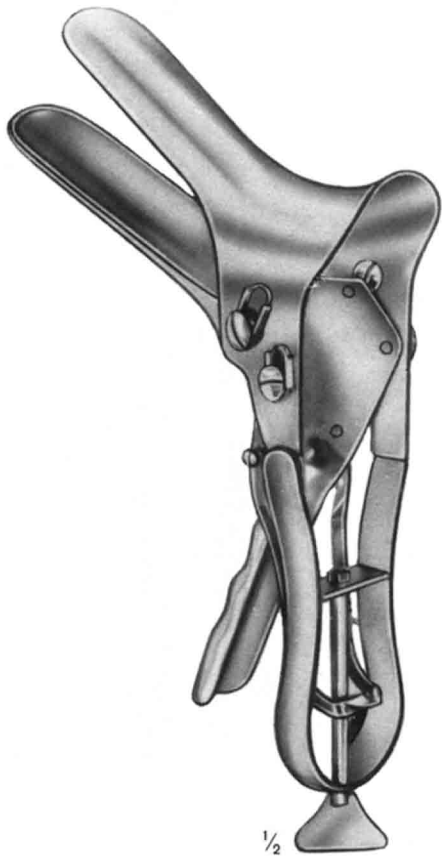

1/2

Seyffert

GI-1700-01	100x17 mm
GI-1700-02	110x33 mm

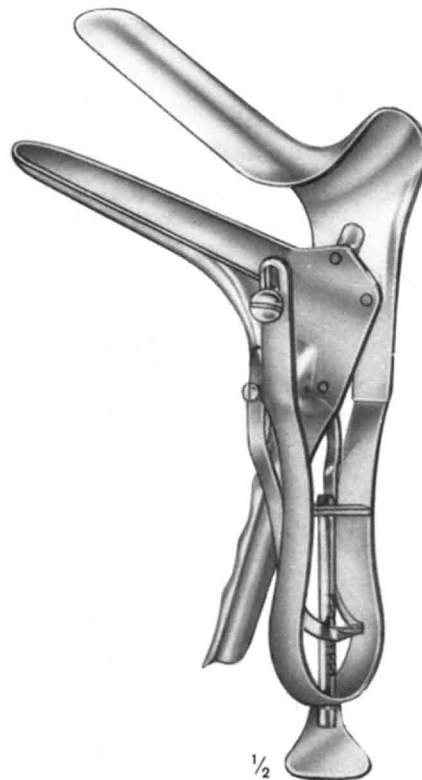

1/2

Seyffert

GI-1701-02

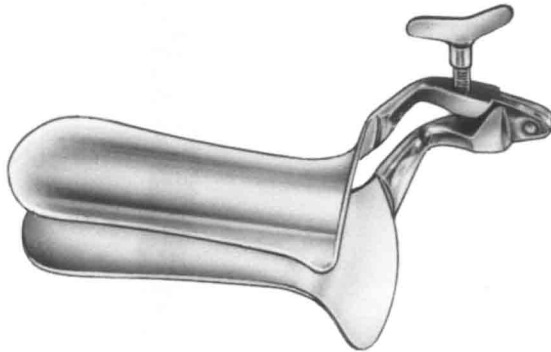
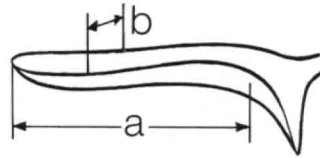

Collin

a	b	
mm	mm	
90	30	GI-1300-01
95	35	GI-1300-02
105	40	GI-1300-03

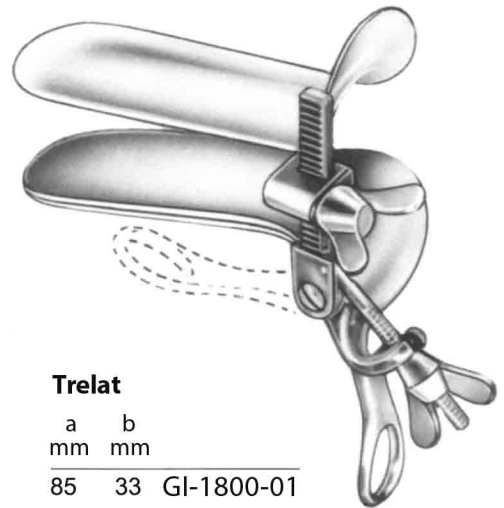

Trelat

a	b	
mm	mm	
85	33	GI-1800-01
95	35	GI-1800-02
115	43	GI-1800-03



Semm

a	b	
mm	mm	
100	17/20	GI-1900-01
100	25/30	GI-1900-02

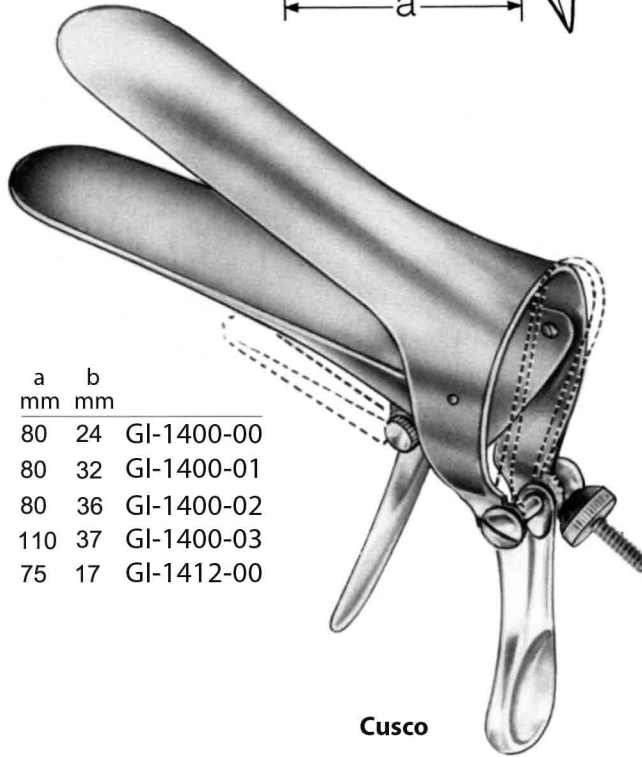
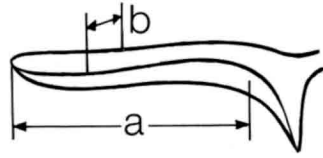

a	b	
mm	mm	
80	24	GI-1400-00
80	32	GI-1400-01
80	36	GI-1400-02
110	37	GI-1400-03
75	17	GI-1412-00

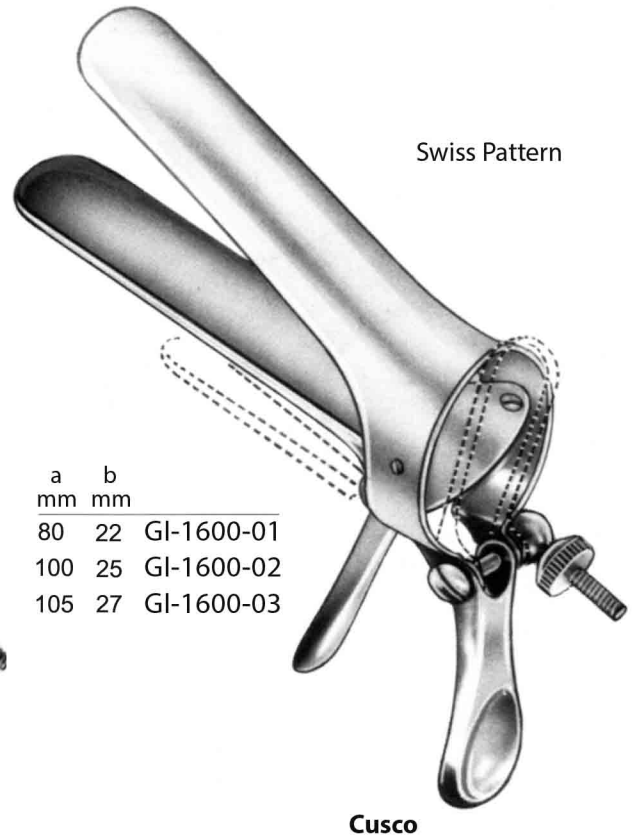

a	b	
mm	mm	
80	22	GI-1600-01
100	25	GI-1600-02
105	27	GI-1600-03

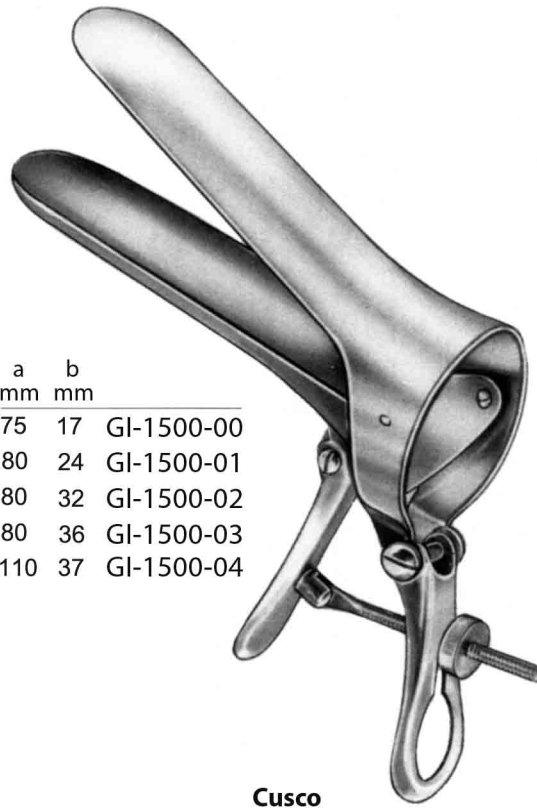

a	b	
mm	mm	
75	17	GI-1500-00
80	24	GI-1500-01
80	32	GI-1500-02
80	36	GI-1500-03
110	37	GI-1500-04



1/2
Kristeller

Specula

		a	b
Fig.0	GI-2101-00	70x15 mm	
Fig.1	GI-2101-01	70x27 mm	
Fig.2	GI-2101-02	75x30 mm	
Fig.3	GI-2101-03	90x36 mm	



1/2
Kristeller

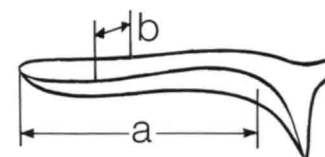

Retractors

		a	b
Fig.0	GI-2102-00	70x15 mm	
Fig.1	GI-2102-01	75x23 mm	
Fig.2	GI-2102-02	80x26 mm	
Fig.3	GI-2102-03	95x32 mm	



1/2
Kristeller

Set of 1 Speculum 1 Retractors

Fig.0	GI-2100-00
Fig.1	GI-2100-01
Fig.2	GI-2100-02
Fig.3	GI-2100-03



1/2
Kristeller

Specula

		a	b
Fig.00	GI-2201-01	110x18 mm	
Fig.0	GI-2201-02	110x21 mm	
Fig.1	GI-2301-01	110x27 mm	
Fig.2	GI-2301-02	110x30 mm	
Fig.3	GI-2301-03	110x36 mm	



1/2
Kristeller

Retractors

		a	b
Fig.00	GI-2202-01	115x14 mm	
Fig.0	GI-2202-02	115x17 mm	
Fig.1	GI-2302-01	115x23 mm	
Fig.2	GI-2302-02	115x26 mm	
Fig.3	GI-2302-03	115x32 mm	



1/2
Kristeller

Set of 1 Speculum 1 Retractors

Fig.00	GI-2200-01
Fig.0	GI-2200-02
Fig.1	GI-2300-01
Fig.2	GI-2300-02
Fig.3	GI-2300-03

Extra large pattern



SET

Kristeller

GI-2500-00



Speculum

Kristeller

135x36 mm

GI-2501-00



Vaginal Retractor

Kristeller

140x30 mm

GI-2502-00



SET

Kristeller

Fig.1 GI-2400-01

Fig.2 GI-2400-02

Fig.3 GI-2400-03

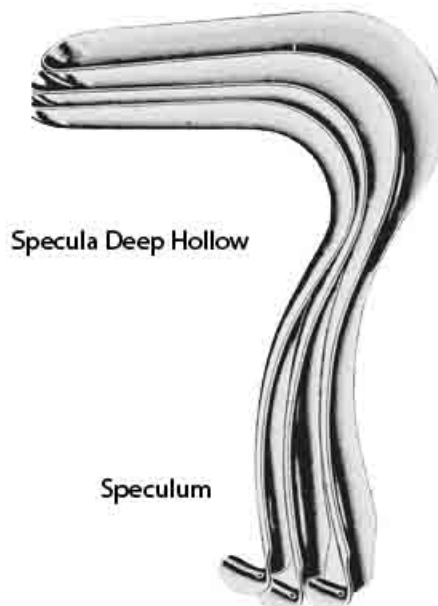

Specula Deep Hollow

Speculum

Kristeller

Fig.1 GI-2401-01 110x27 mm

Fig.2 GI-2401-02 110x30 mm

Fig.3 GI-2401-03 110x36 mm

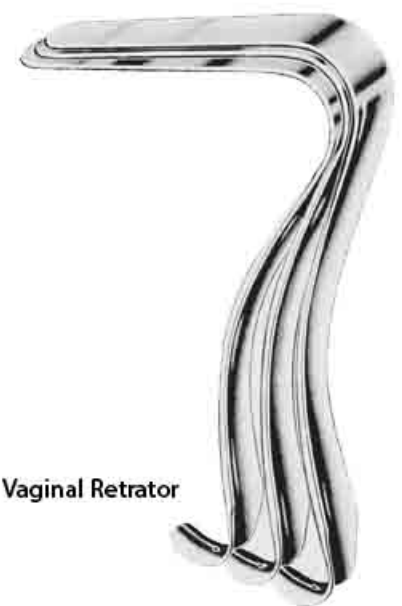

Vaginal Retractor

Kristeller

Fig.1 GI-2402-01 115x23 mm

Fig.2 GI-2402-02 115x26 mm

Fig.3 GI-2402-03 115x32 mm

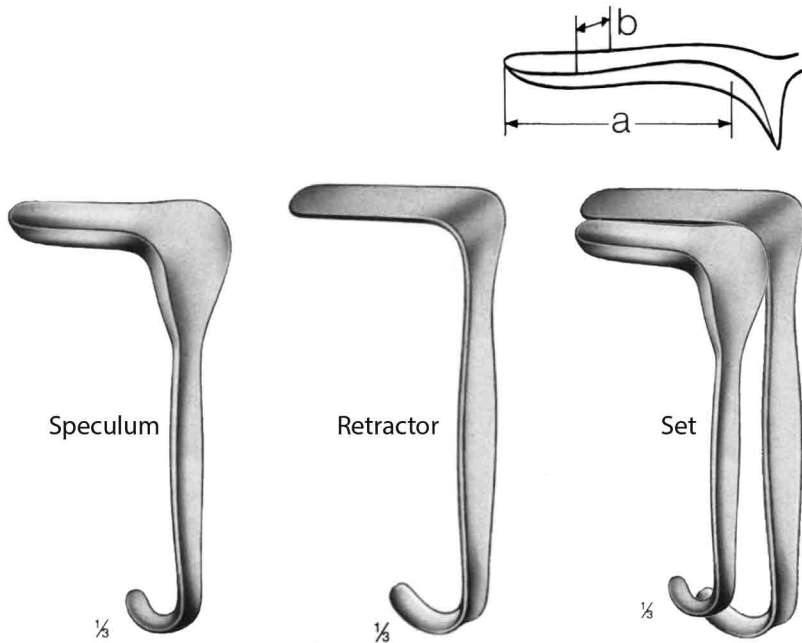

Kallmorgen

Kallmorgen

	a	b		a	b			
GI-2601-02	70	40	mm	GI-2602-01	70	30	mm	GI-2600-01
GI-2601-01	90	40	mm	GI-2602-02	90	30	mm	GI-2600-02

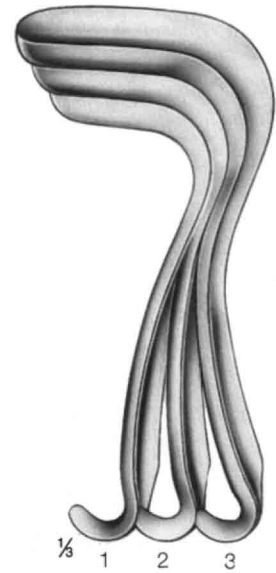

Sims

18 cm/7.2"

	a	b	
Fig.1 GI-2801-01	70	27	mm
Fig.2 GI-2801-02	75	30	mm
Fig.3 GI-2801-03	90	36	mm

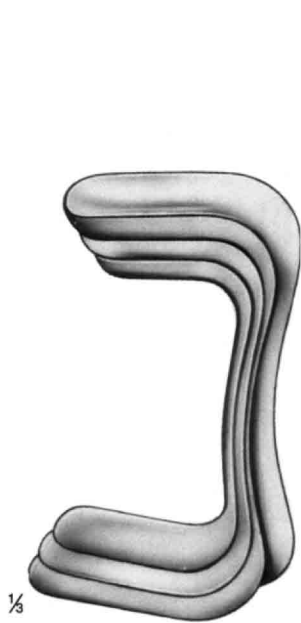

Sims

	a	b	
GI-2901-01	25	30	mm
GI-2901-02	30	35	mm
GI-2901-03	35	40	mm
GI-2901-00	Set		



Auvard

	a	b	
GI-3007-00	75	40	mm
GI-3007-10	105	40	mm



Auvard

	a	b	
GI-3008-10	83	38	mm
GI-3009-00	105	40	mm

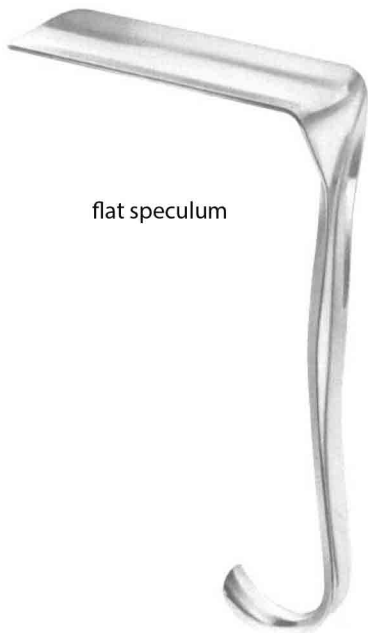

flat speculum

Jackson



GI-2701-01

75 x 40 mm



GI-2701-02

90 x 40 mm



GI-2701-03

100 x 40 mm

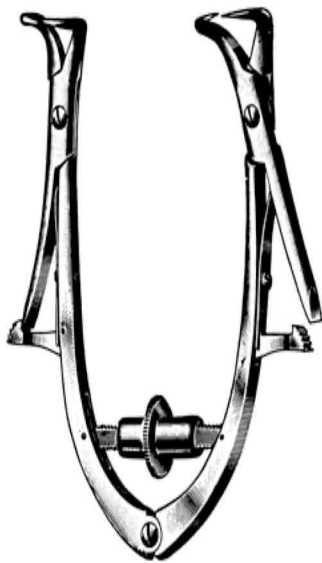

Friedmann

10 cm/4"

GI-3501-10

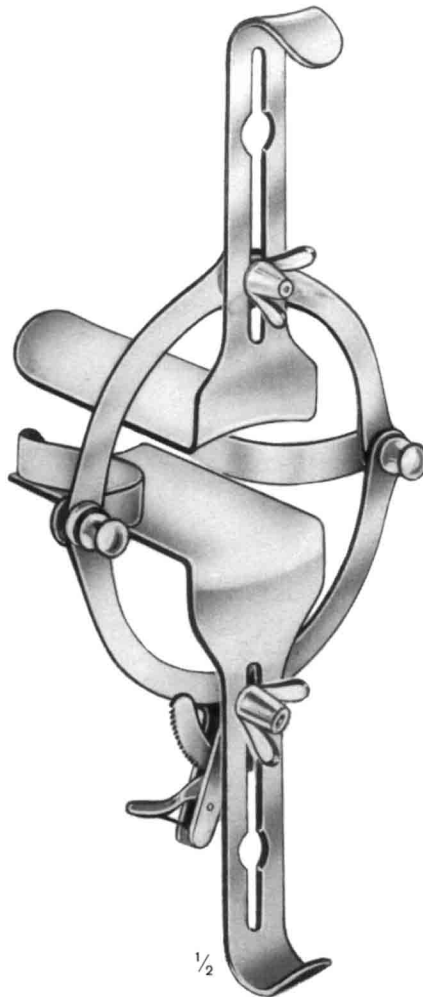

O'Sullivan-O'Connor

GI-3505-00

complete with 3 blades



1

2

3

1/2

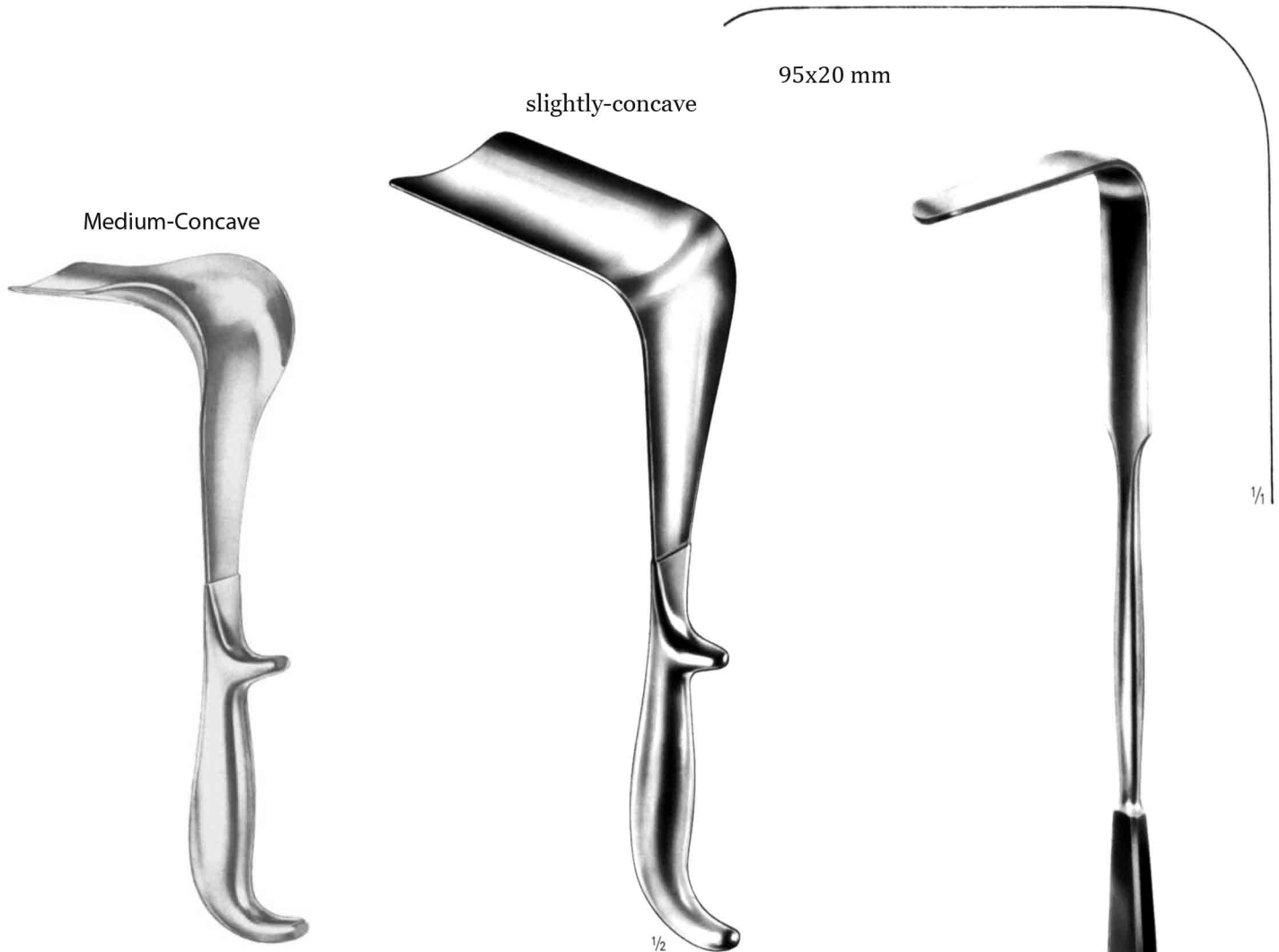

Medium-Concave

Doyen

Fig

1	GI-3000-01	60x45 mm
2	GI-3000-02	90x45 mm
3	GI-3000-03	120x45 mm

slightly-concave

95x20 mm

Doyen

1/2

24 cm/19.6"

Fig

1	GI-3001-01	60x35 mm
2	GI-3001-02	90x35 mm
3	GI-3001-03	120x35 mm

1	GI-3003-01	60x45 mm
2	GI-3003-02	90x45 mm
3	GI-3003-03	120x45 mm
4	GI-3003-04	160x45 mm

1	GI-3005-01	60x60 mm
2	GI-3005-02	90x60 mm
3	GI-3005-03	120x60 mm
4	GI-3005-04	160x60 mm

1/1

1/2

Modell Tubingen

28 cm/11.2"

GI-3031-28

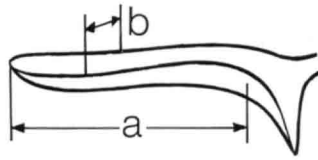

Braun
18 cm/7.2"
GI-3021-01

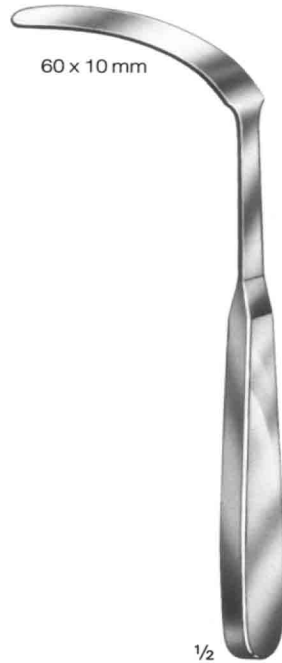

Braun
18 cm/7.2"
GI-3021-02



Doyen

	cm	in.	a	b
GI-3107-23N	23	9	60 x 30 mm	
GI-3107-24N	24	9 ½	70 x 30 mm	
GI-3107-25N	25	10	80 x 30 mm	



Landau
30 cm/12"
GI-3109-28 100 x 28 mm
GI-3109-38 110 x 38 mm



Mathieu
21 cm/8.4"
GI-1780-21N



Mathieu
21 cm/8.4"
GI-1781-21N

Endo Speculum

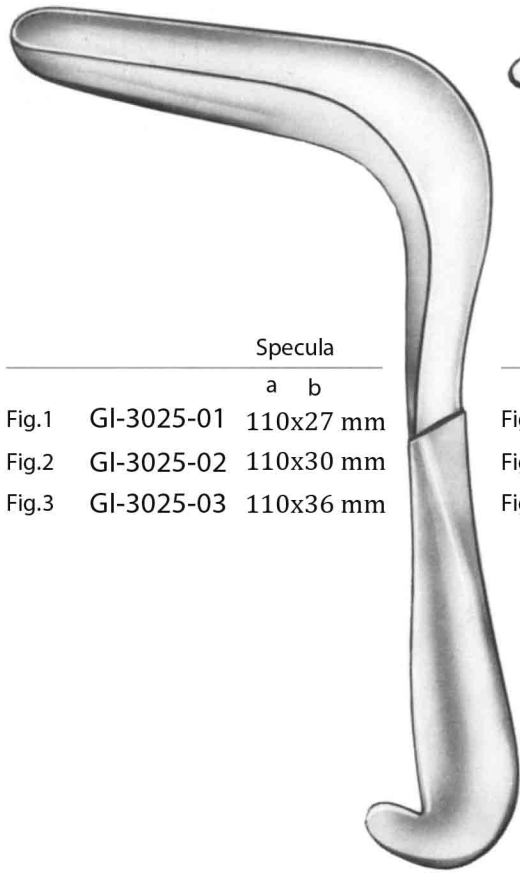

		Specula	
		a	b
Fig.1	GI-3025-01	110x27 mm	
Fig.2	GI-3025-02	110x30 mm	
Fig.3	GI-3025-03	110x36 mm	

21,5 cm/8.6"

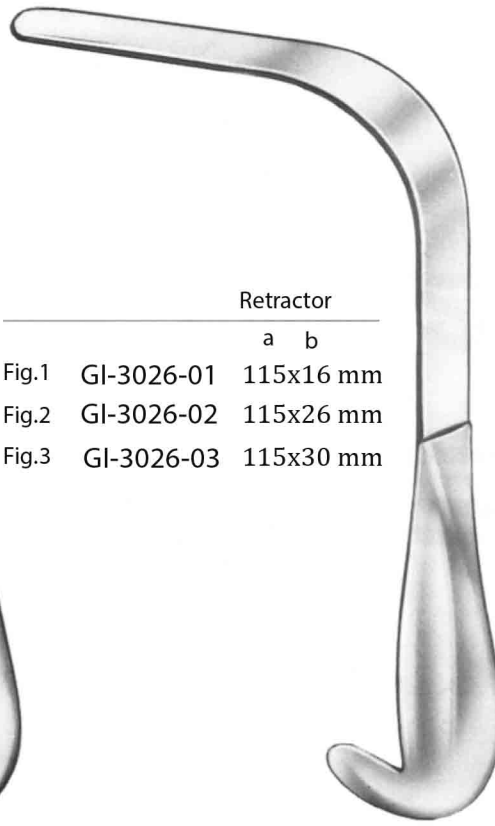

		Retractor	
		a	b
Fig.1	GI-3026-01	115x16 mm	
Fig.2	GI-3026-02	115x26 mm	
Fig.3	GI-3026-03	115x30 mm	

22 cm/8.8"

		Set
Fig.1	GI-3024-01	
Fig.2	GI-3024-02	
Fig.3	GI-3024-03	

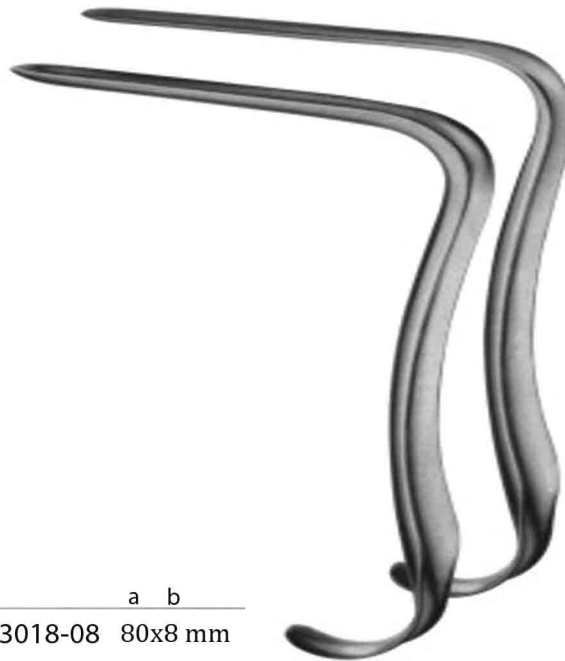

		a	b
Fig.1	GI-3018-08	80x8 mm	
Fig.2	GI-3018-14	80x10 mm	
Fig.3	GI-3018-10	90x14 mm	

Seidl



GI-3043-99
Handle only

grs
400 GI-3043-40
800 GI-3043-80

1/2

Scherbak
GI-3040-00
Set compl



1/4
GI-3041-01
80x30 mm



1/4
GI-3041-02
85x35 mm



1/4
GI-3041-03
90x40 mm



1/4
GI-3041-04
55x40/60 mm



1/4
GI-3041-05
70x45/70 mm

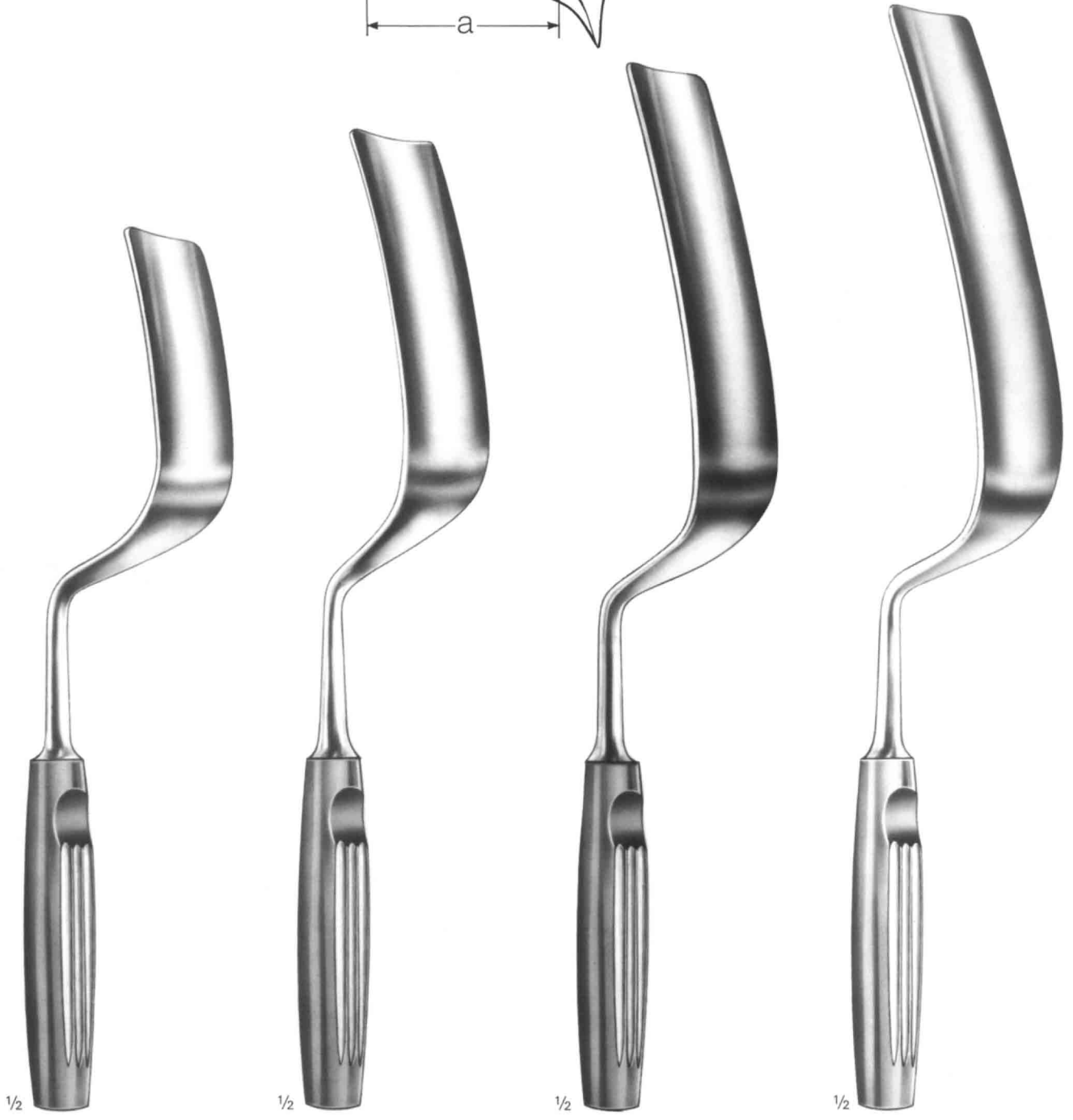
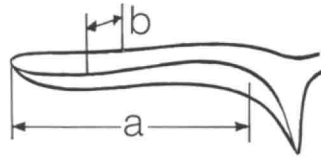

Breisky 29cm/11.6" $\frac{1}{2}$ a b **Breisky** 32 cm/12.8" $\frac{1}{2}$ a b **Breisky** 35 cm/14" $\frac{1}{2}$ a b **Breisky** 37 cm/14.8" $\frac{1}{2}$ a b

GI-3100-20	100x20 mm	GI-3103-20	130x20 mm	GI-3105-25	160x25 mm	GI-3106-40	180x40 mm
GI-3100-25	100x25 mm	GI-3103-25	130x25 mm	GI-3105-40	160x25 mm		
GI-3100-30	100x30 mm	GI-3103-30	130x30 mm				
GI-3100-35	100x35 mm	GI-3103-35	130x35 mm				
GI-3100-40	100x40 mm	GI-3103-40	130x40 mm				

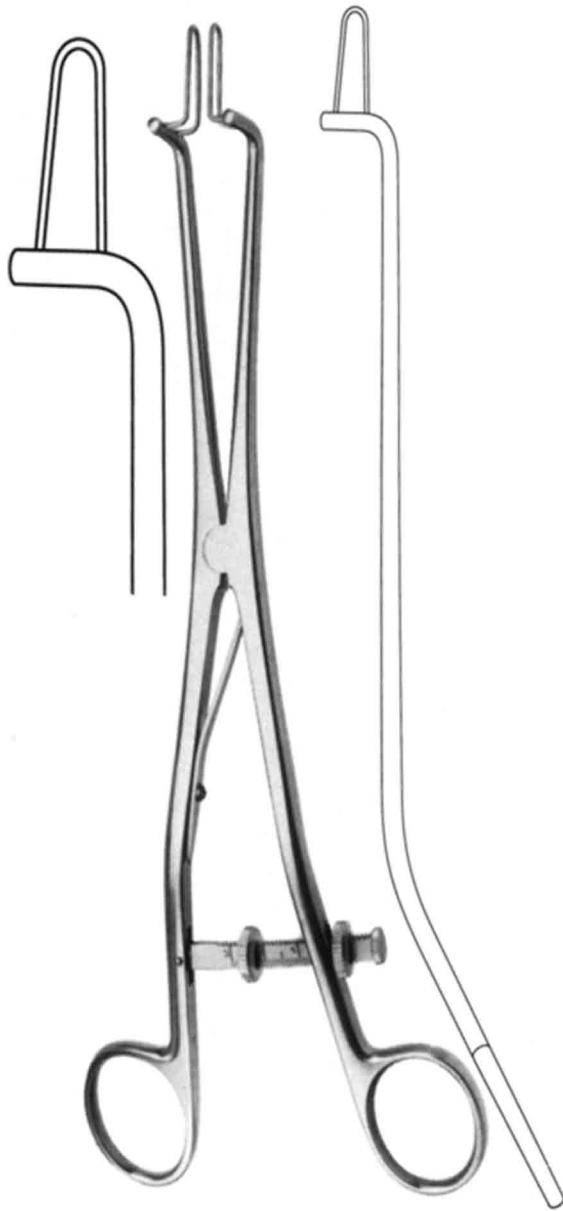

Kogan

	Standard	cm	Laser
3mm	GI-3600-24	24cm/9.6"	GI-3604-24
4mm	GI-3601-24	24cm/9.6"	GI-3605-24
5mm	GI-3602-24	24cm/9.6"	GI-3606-24



Kogan

24cm/9.6"
GI-3604-24

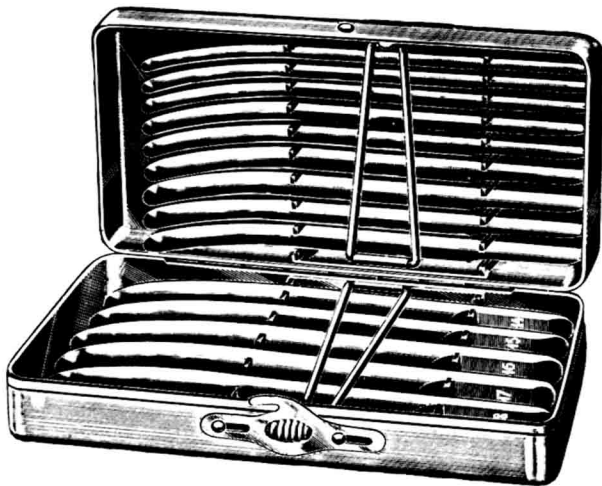

GI-4006-14
Set of 14 dilators 4-17 mm Ø



GI-4005-14
Set of 14 dilators 4-17 mm Ø

GI-4006-26
Set of 26 dilators 1-26 mm Ø



Hegar

mm Ø

1,0	GI-4100-01
2,0	GI-4100-02
3,0	GI-4100-03
4,0	GI-4100-04
5,0	GI-4100-05
6,0	GI-4100-06
7,0	GI-4100-07
8,0	GI-4100-08
9,0	GI-4100-09
10,0	GI-4100-10
11,0	GI-4100-11
12,0	GI-4100-12
13,0	GI-4100-13
14,0	GI-4100-14
15,0	GI-4100-15
16,0	GI-4100-16
17,0	GI-4100-17
18,0	GI-4100-18
19,0	GI-4100-19
20,0	GI-4100-20
21,0	GI-4100-21
22,0	GI-4100-22
23,0	GI-4100-23
24,0	GI-4100-24
25,0	GI-4100-25
26,0	GI-4100-26
27,0	GI-4100-27
28,0	GI-4100-28
29,0	GI-4100-29
30,0	GI-4100-30

mm Ø

1,5	GI-4105-01
2,5	GI-4105-02
3,5	GI-4105-03
4,5	GI-4105-04
5,5	GI-4105-05
6,5	GI-4105-06
7,5	GI-4105-07
8,5	GI-4105-08
9,5	GI-4105-09
10,5	GI-4105-10
11,5	GI-4105-11
12,5	GI-4105-12
13,5	GI-4105-13
14,5	GI-4105-14
15,5	GI-4105-15
16,5	GI-4105-16
17,5	GI-4105-17
18,5	GI-4105-18
19,5	GI-4105-19



Hawkin Ambler

	mm
GI-4280-03	3 / 6
GI-4280-04	4 / 7
GI-4280-05	5 / 6
GI-4280-06	6 / 9
GI-4280-07	7 / 10
GI-4280-08	8 / 11
GI-4280-09	9 / 12
GI-4280-10	10 / 13
GI-4280-11	11 / 14
GI-4280-12	12 / 15
GI-4280-13	13 / 16
GI-4280-14	14 / 17



Pratt

	Charr./F.G.
GI-4290-13	13 / 15
GI-4290-17	17 / 19
GI-4290-21	21 / 23
GI-4290-25	25 / 27
GI-4290-29	29 / 31
GI-4290-33	33 / 35
GI-4290-37	37 / 39
GI-4290-41	41 / 43
GI-4290-45	45 / 47
GI-4290-49	49 / 51
GI-4290-53	53 / 55
GI-4290-57	57 / 59
GI-4290-00	Set compl.



Hegar

	mm Ø
GI-4200-01	1+ 2
GI-4200-03	3+ 4
GI-4200-05	5+ 6
GI-4200-07	7+ 8
GI-4200-09	9+ 10
GI-4200-11	11+ 12
GI-4200-13	13+ 14
GI-4200-15	15+ 16
GI-4200-17	17+ 18
GI-4200-19	19+ 20
GI-4200-21	21+ 22
GI-4200-23	23+ 24
GI-4200-25	25+ 26

GI-4205-08

Set of 8 dilators

3.0/4.0 – 17.0/18.0 mm Ø

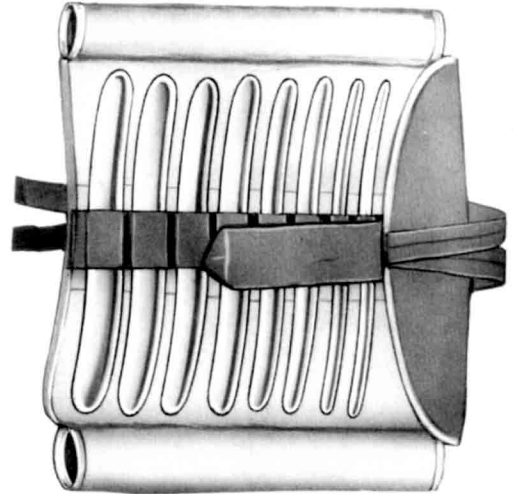

Hegar

GI-4206-08

Set of 8 dilators

3.0/4.0 – 17.0/18.0 mm Ø

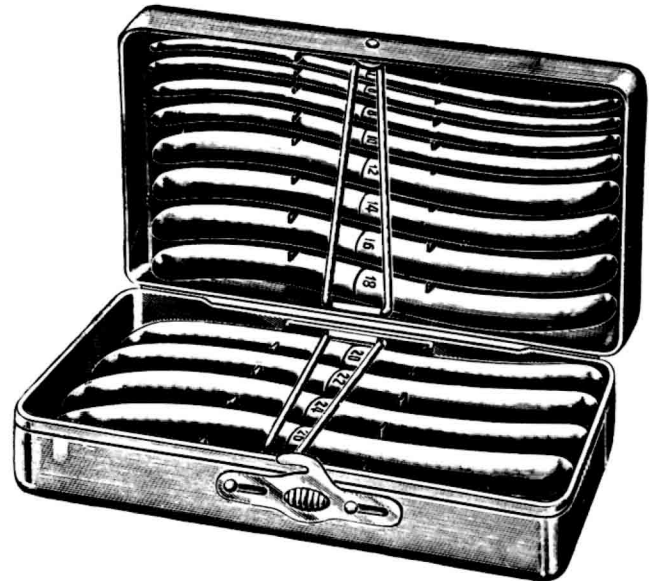

Hegar

GI-4206-13

Set of 13 dilators

1.0/2.0 – 25.0/26.0 mm Ø



Hank

GI-4300-08	Fig. 7/8	3,5/ 4 mm Ø
GI-4300-10	Fig. 9/10	4,5/ 5 mm Ø
GI-4300-12	Fig. 11/12	5,5/ 6 mm Ø
GI-4300-14	Fig. 13/14	6,5/ 7 mm Ø
GI-4300-16	Fig. 15/16	7,5/ 8 mm Ø
GI-4300-18	Fig. 17/18	8,5/ 9 mm Ø
GI-4300-20	Fig. 19/20	9,5/10 mm Ø

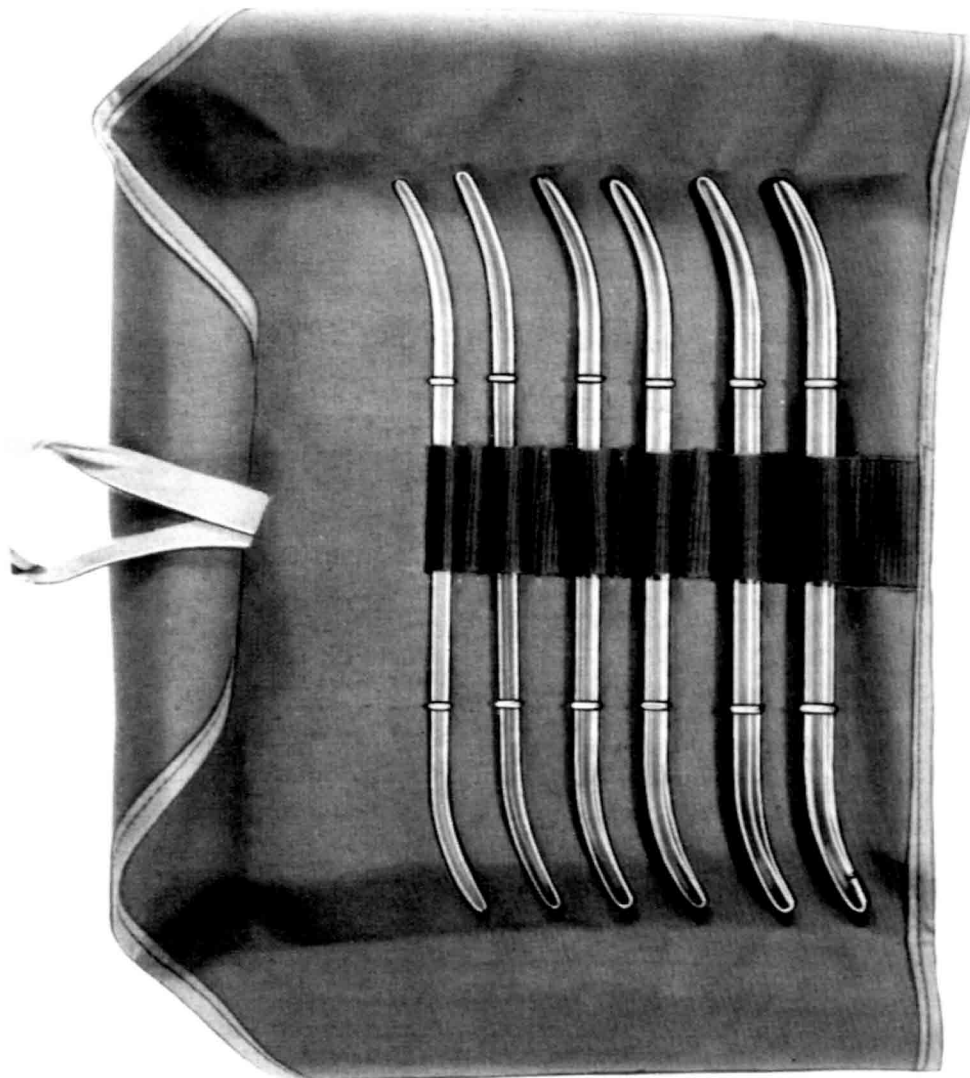

½

Hank

GI-4306-08 Compl. Set in Pouch



Goodell

34 cm/13.6"

GI-4401-34



Wylie

29cm/11.6"

GI-4403-29



Sims

29cm/11.6"

GI-4405-29



Martin

26 cm/10.4"

GI-4420-26



Braun

25 cm/10"

GI-5004-25

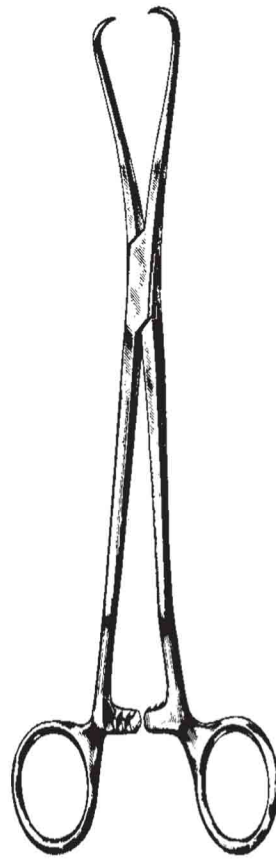

Jarcho

20 cm/8"

GI-5102-20

Tubal seizing forceps



Neubusser

20 cm/8"

GI-8500-06 Ø 6,0 mm

GI-8500-08 Ø 8,0 mm

GI-8500-10 Ø 10,0 mm

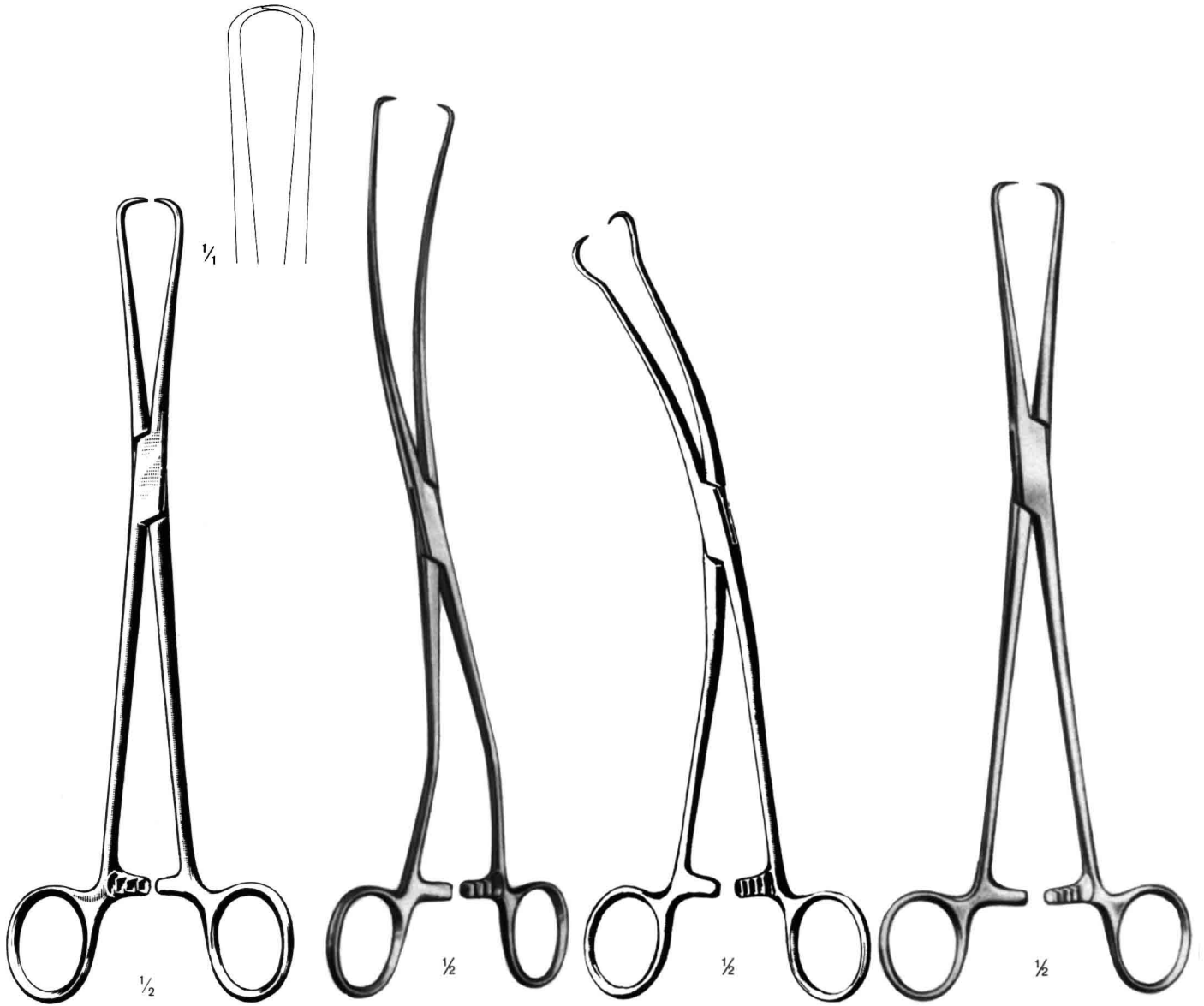

Schroeder

25 cm/10"

GI-5002-25

Duplay

28cm/11"

GI-5007-28

Skene

24cm/9.6"

GI-5005-24

Pozzi

17 cm/6.8" 25,5 cm/10.2"

GI-5006-17 GI-5006-25



Tiemann

22 cm/8.8"

GI-5108-22

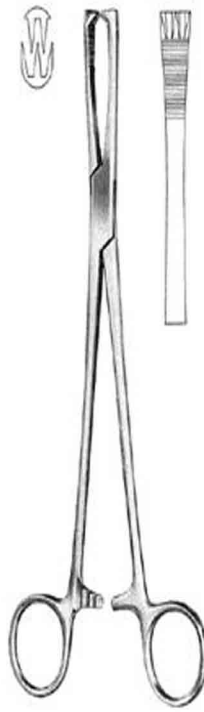

Henrotin

20 cm/8"

GI-5312-20

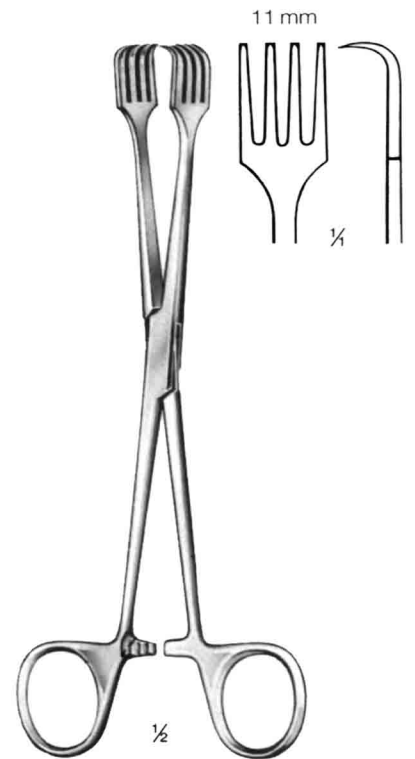

Czemy

20,5 cm/8"

GI-5314-20

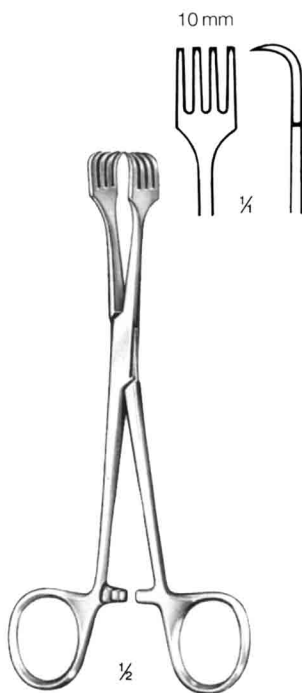

Brown

15,5 cm/6.2"

GI-5318-15

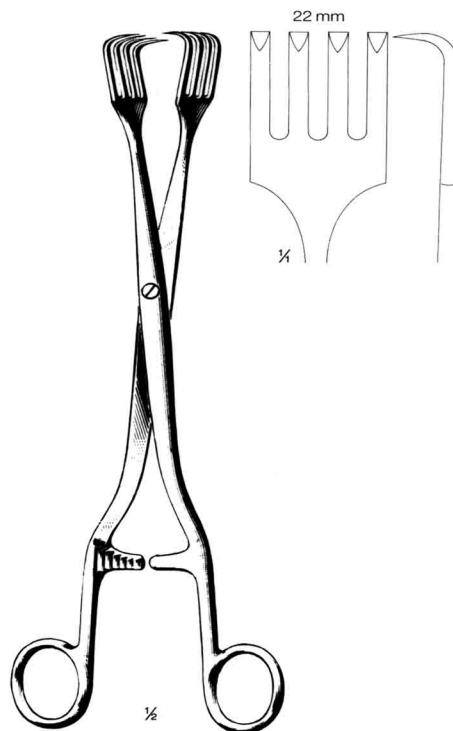

Pratt

28cm/11"

GI-5306-28



Pratt

26 cm/10.4"

GI-5324-26



Museux

24cm/9.6"

GI-4430-20

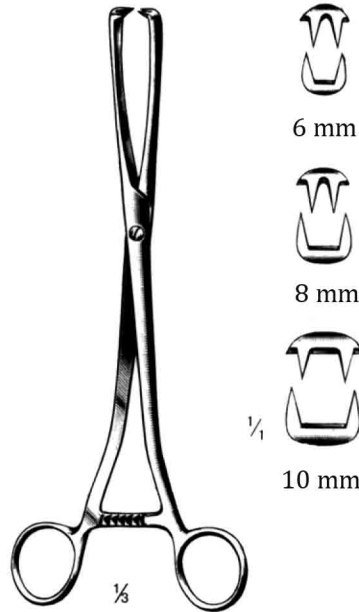

Museux

24cm/9.6"

GI-5204-06 = 6 mm

GI-5204-08 = 8 mm

GI-5204-10 = 10 mm

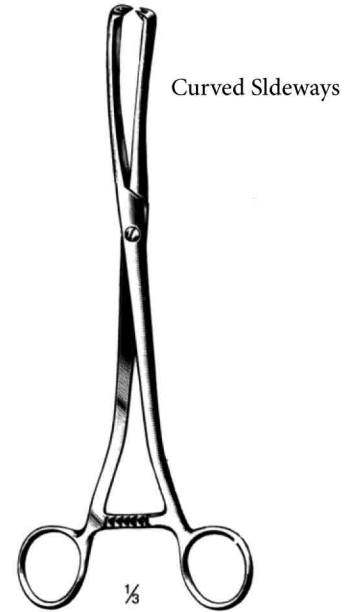

Museux

24cm/9.6"

GI-5205-06 = 6 mm

GI-5205-08 = 8 mm

GI-5205-10 = 10 mm



Teale

23cm/9.2"

GI-5301-23

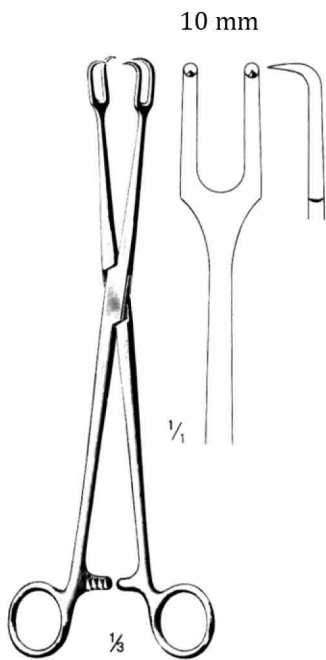

Schroeder

GI-5104-20 20 cm/8"

GI-5104-24 24cm/9.6"

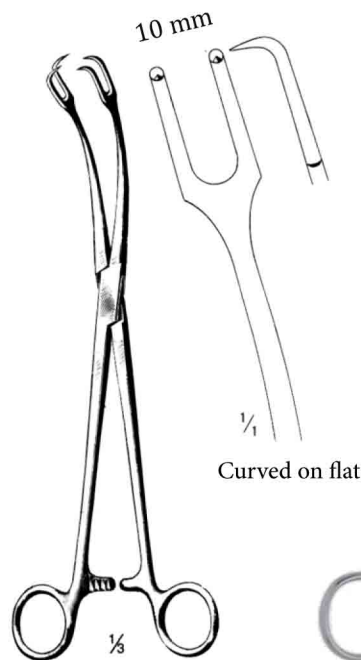

Schroeder

GI-5105-20 20 cm/8"

GI-5105-24 24cm/9.6"

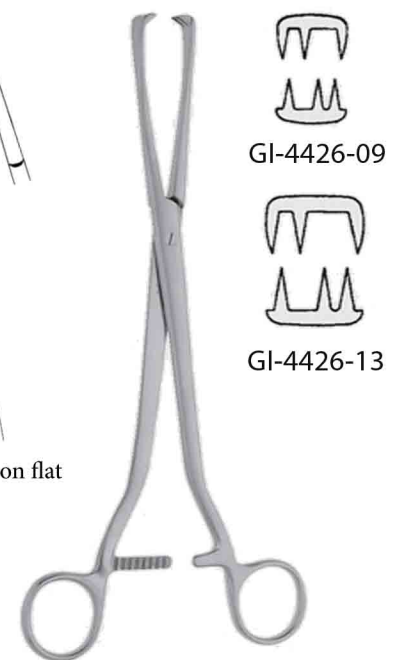

Museux

26 cm/10.4"

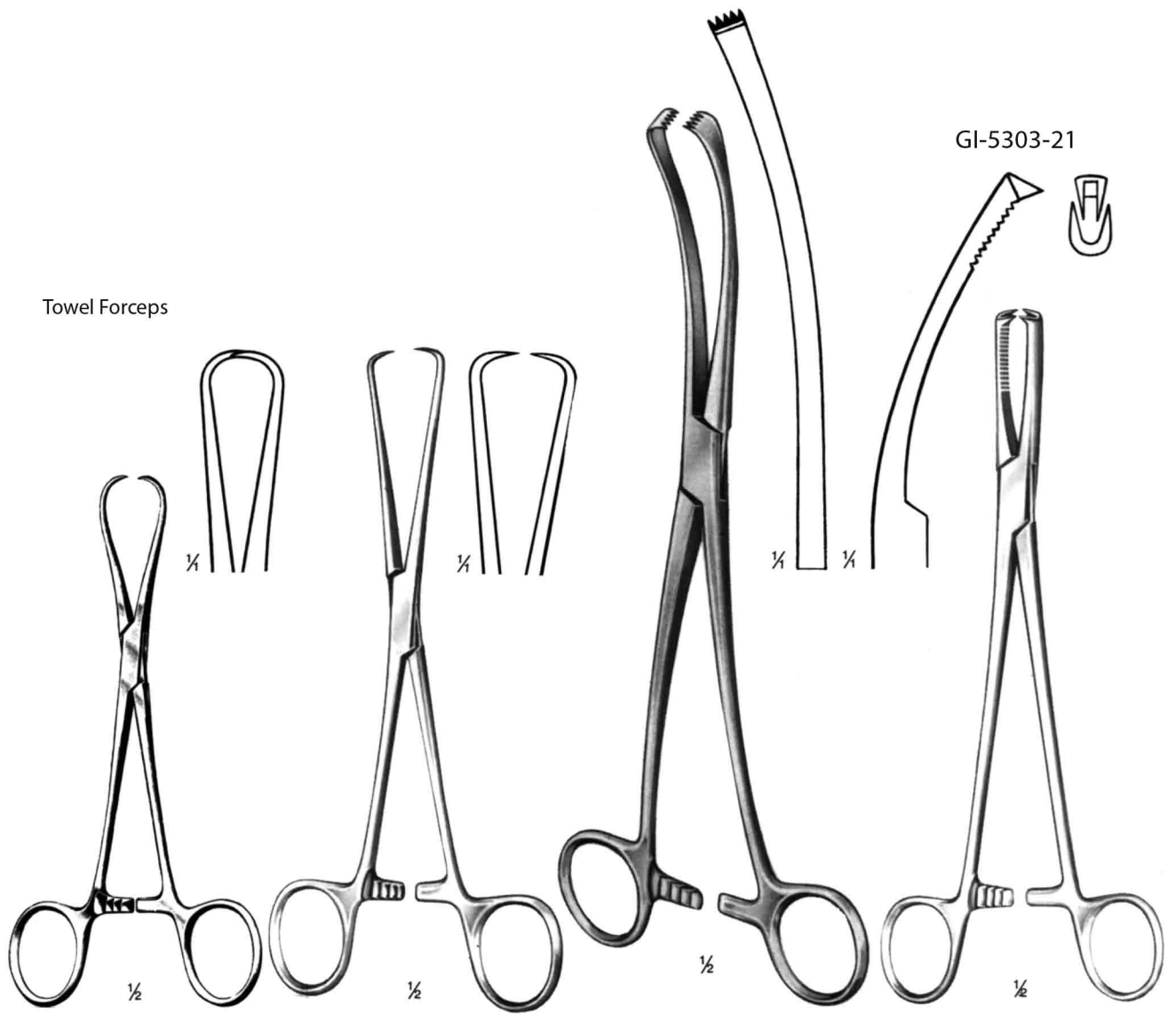

Staude- Moore (Bernhard)

17 cm/6.8"

GI-5008-17

Barrett

18 cm/7.2"

GI-5100-18

Lova

26 cm/10.4"

GI-5309-26

Jacobs

21 cm/8.4"

GI-5302-21 Straight

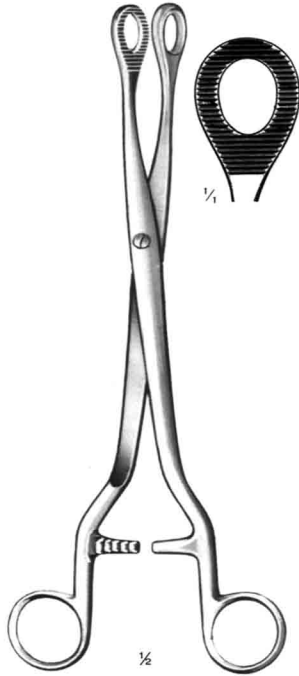

Noto
 27 cm/10.8"
 GI-5400-27



Doyen
 20 cm/8"
 GI-5402-20

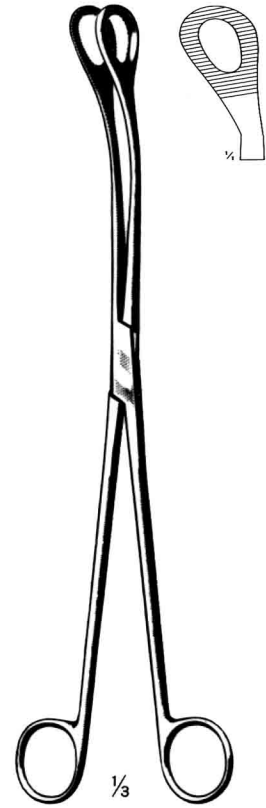

Kelly
 32 cm/12.8"
 GI-5403-32

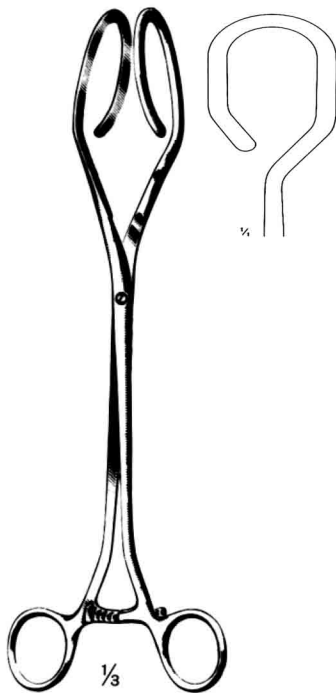

Dartigues
 27 cm/10.8"
 GI-5405-27



Somer
 23cm/9.2"
 GI-5407-23

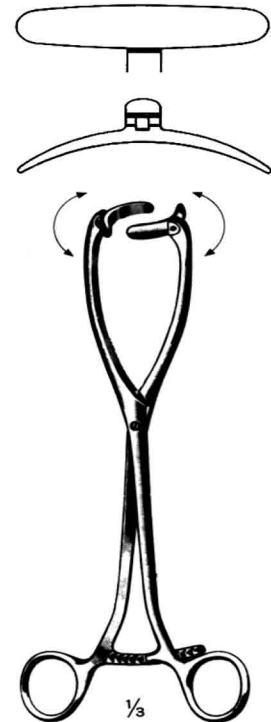

Collin
 25 cm/10"
 GI-5409-25

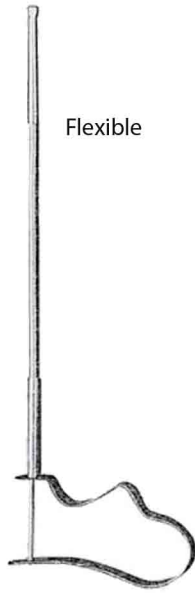

Flexible

I.U.D

GI-5500-30



Extraction Hook

GI-5508-00



Amniotome

Beacham

26 cm/10.4"

GI-5509-26

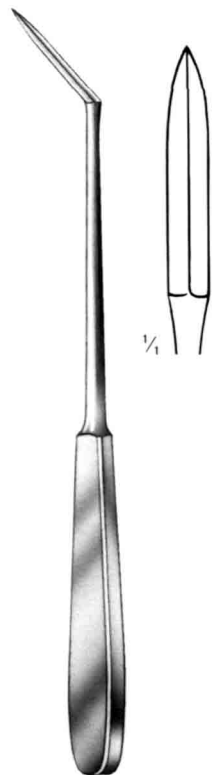

Ayre

23.5cm/9.4"

GI-6415-23

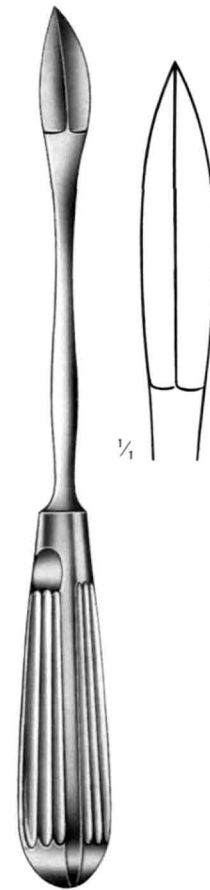

Segond

27 cm/10.8"

GI-6411-27

Uterine Sounds

Graduated in centimeters

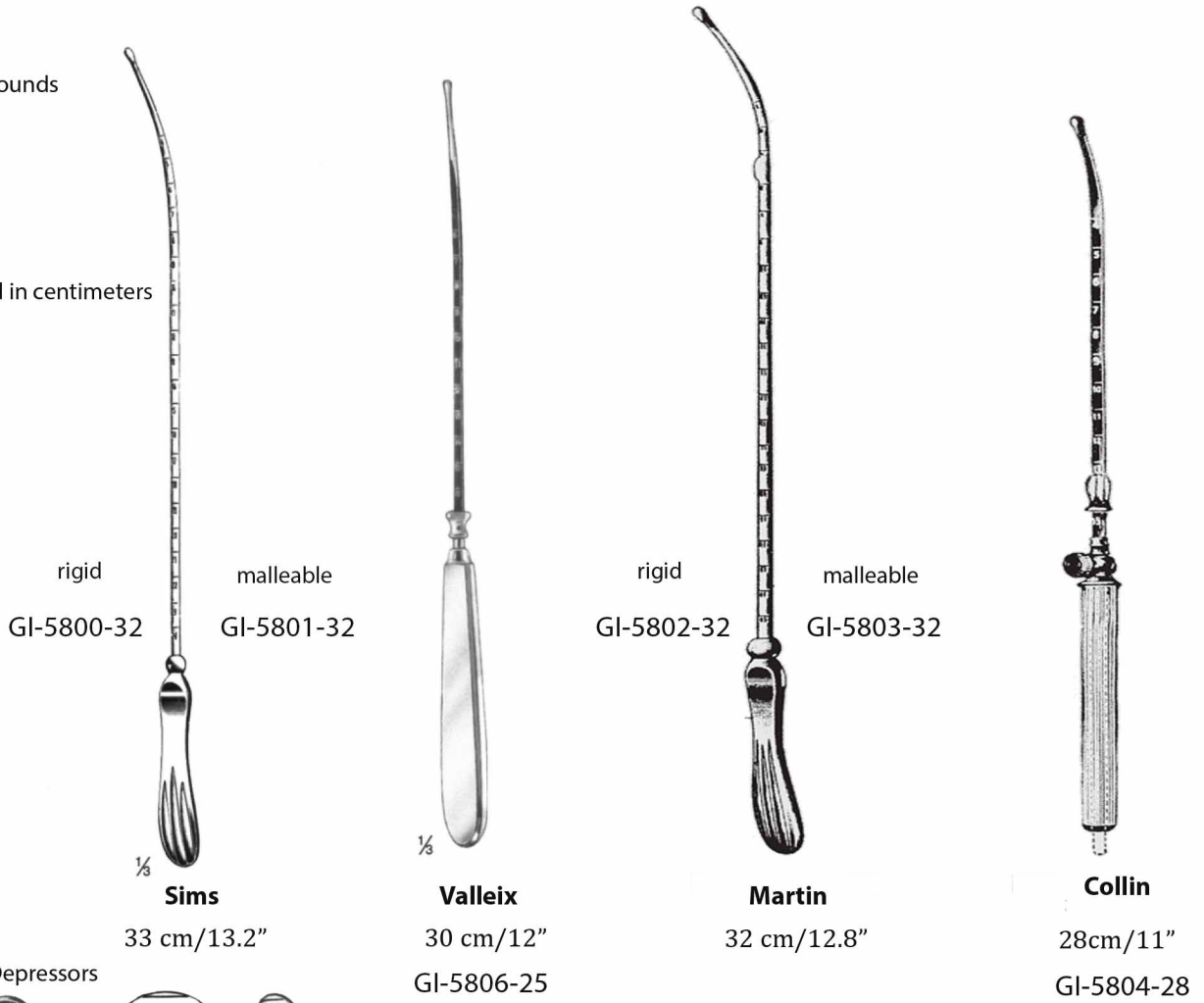

rigid
GI-5800-32

malleable
GI-5801-32

rigid
GI-5802-32

malleable
GI-5803-32

$\frac{1}{8}$
Sims
33 cm/13.2"

$\frac{1}{8}$
Valleix
30 cm/12"
GI-5806-25

Martin
32 cm/12.8"

Collin
28cm/11"
GI-5804-28

Uterine Depressors

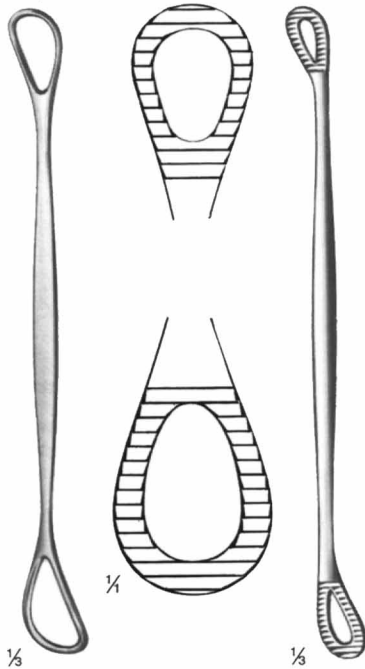

$\frac{1}{8}$
Braun
28cm/11"
GI-5605-28

$\frac{1}{8}$
Sims
26 cm/10.4"
GI-5607-26



$\frac{1}{8}$
Doyen
17 cm/6.8"
GI-6402-17



$\frac{1}{8}$
Doyen
17 cm/6.8"
GI-6401-17

Endometrial Biopsy Curette



Mod. Berlin
27 cm/10.8"
GI-5890-04

Uterine Biopsy Aspirating Curettes



Randall
25 cm/10"
GI-5900-04

Aspirating curettes

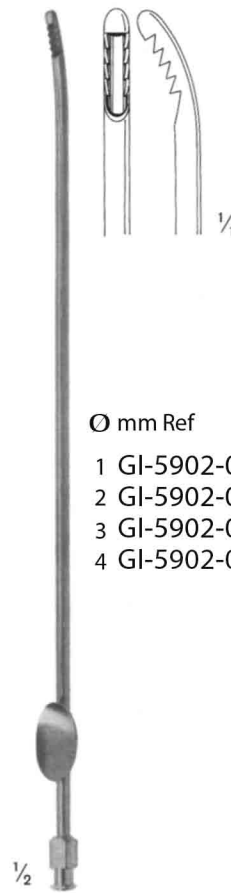

Novak
25 cm/10"

Uterine Biopsy Curettes



Kevorkian
30 cm/12"

Uterine Biopsy Curettes



Heaney
24cm/9.6"
GI-5918-24



Rhein Staedter

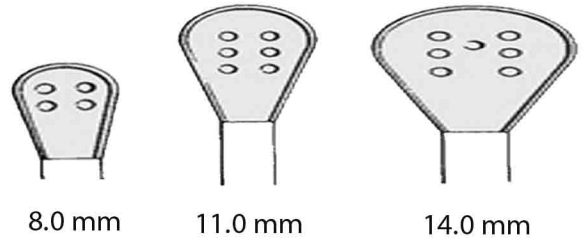

	Sharp	mm	Blunt
	GI-5930-08	8.0	GI-5931-08
	GI-5930-11	11.0	GI-5931-11
	GI-5930-14	14.0	GI-5931-14



Emmet

24cm/9.6"

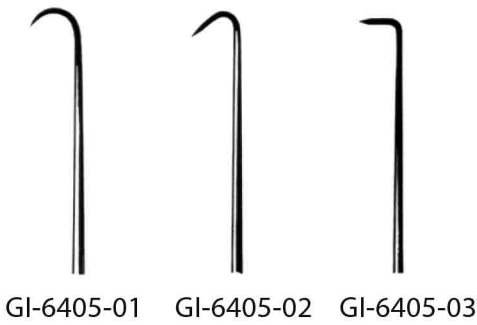

GI-6405-01

GI-6405-02

GI-6405-03



GI-6405-04

GI-6405-05



Simon

24cm/9.6"

GI-6408-22



Simon

24cm/9.6"

GI-6409-22

Intra uterine cannula



10 × 25 mm
GI-6600-10



13 × 30 mm
GI-6600-13



16 × 30 mm
GI-6600-16

Leech-Wilkinson

27 cm/10.8"

Uterine Curettes



Collin
28cm/11"



GI-7410-08
8 mm



GI-7410-10
10 mm



GI-7410-12
12 mm



GI-7410-14
14 mm

Nucus Evacuatar



Carton

30 cm/12"
5 mm dia
GI-6615-23

Uterine flushing tube



Bozemann-Fritsch

GI-7425-08 8 mm dia
GI-7425-10 10 mm dia

Uterine Biopsy Curettes



Kelly Gray
24cm/9.6"



Fig.1

GI-5910-05
5.0 mm



Fig.2

GI-5910-06
6.0 mm



Fig.3

GI-5910-07
7.0 mm



Fig.4

GI-5910-08
8.0 mm

Uterine Biopsy Curettes



Milan
28cm/11"



¼

Fig.1

GI-5914-04



¼

Fig.2

GI-5914-06



¼

Fig.3

GI-5914-09



Faure

23cm/9.2"

GI-6001-21



Schubert

GI-6004-21 21 cm/8.4"

GI-6004-28 29cm/11.6"



Schubert

26 cm/10.4"

GI-6005-26



Thoms-Gaylor

24cm/9.6"

GI-6006-24



Gellhorn

23cm/9.2"

GI-6009-23

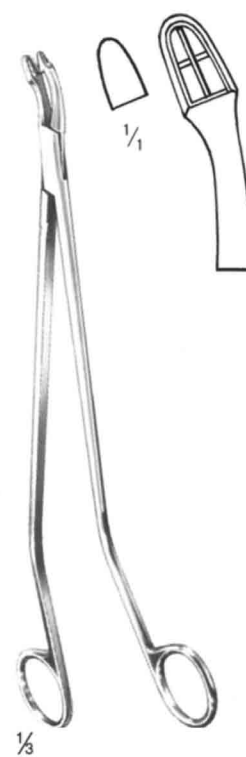

Van Doren

25 cm/10"

GI-6101-25

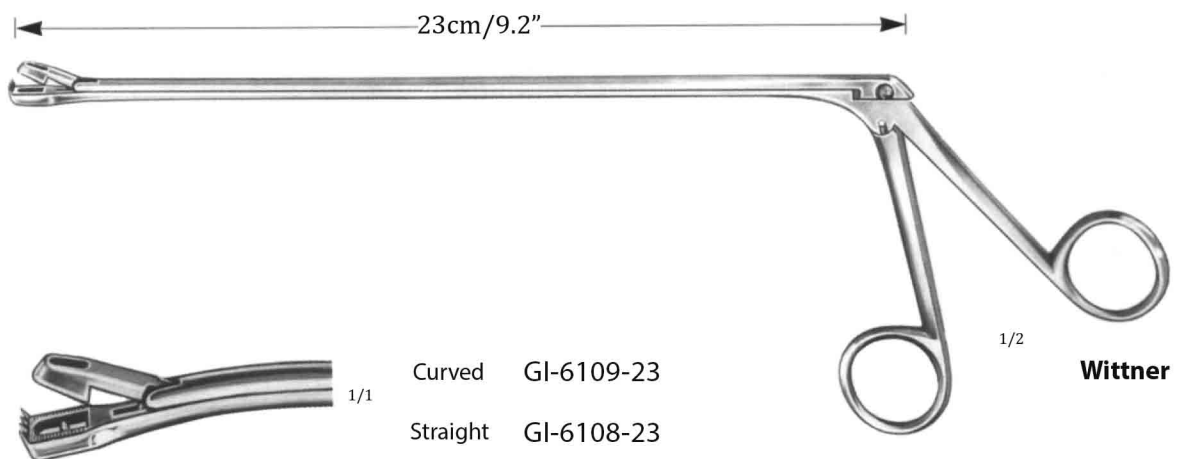
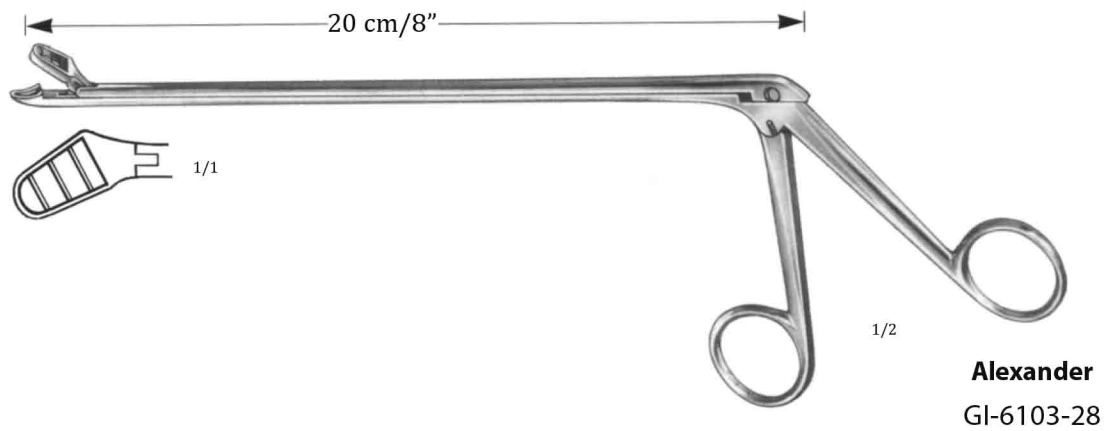
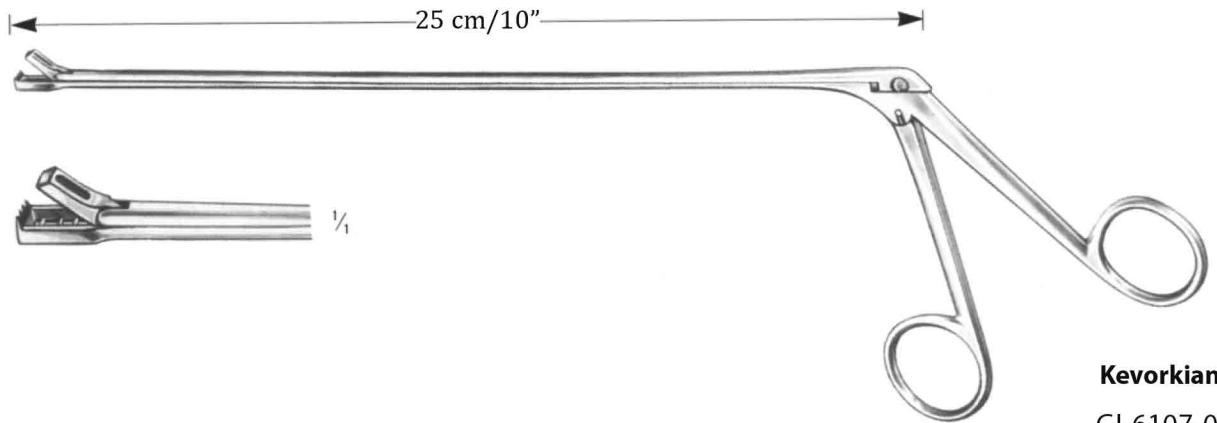

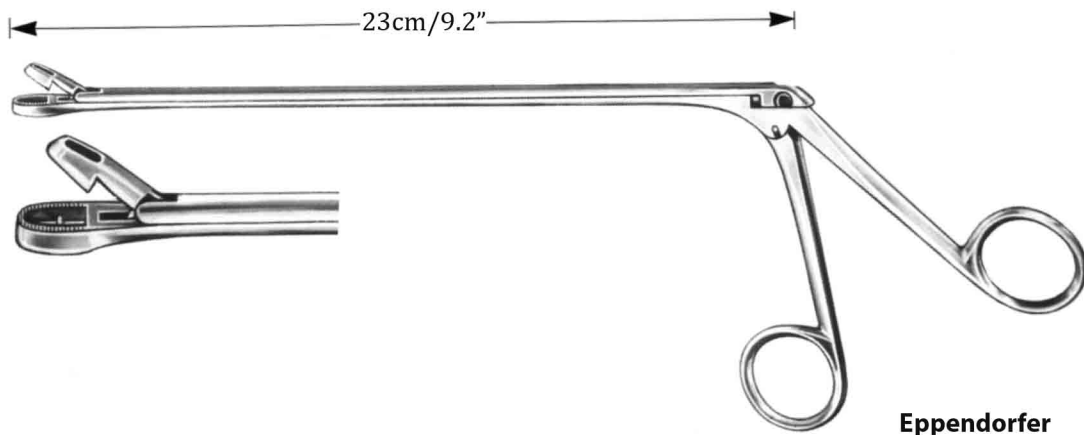

Eppendorfer
GI-6300-00

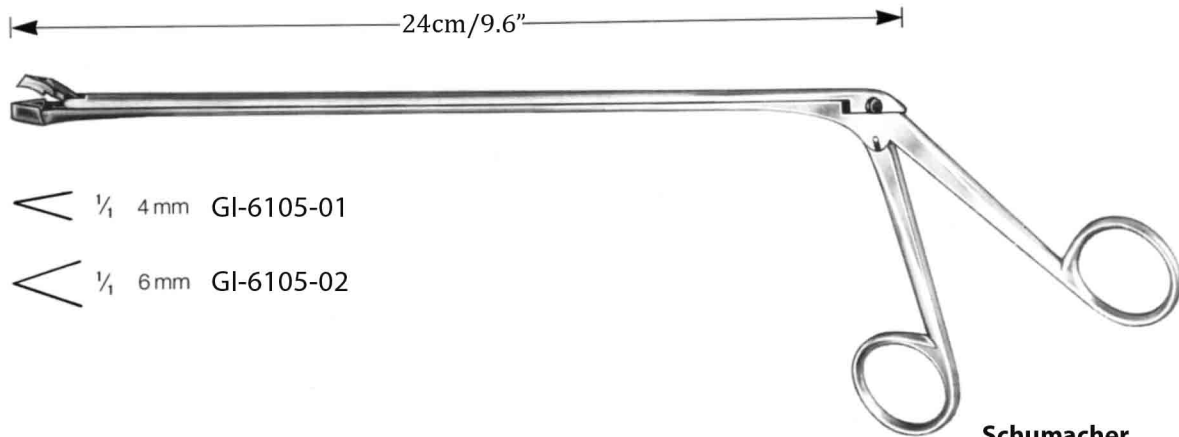

Schumacher

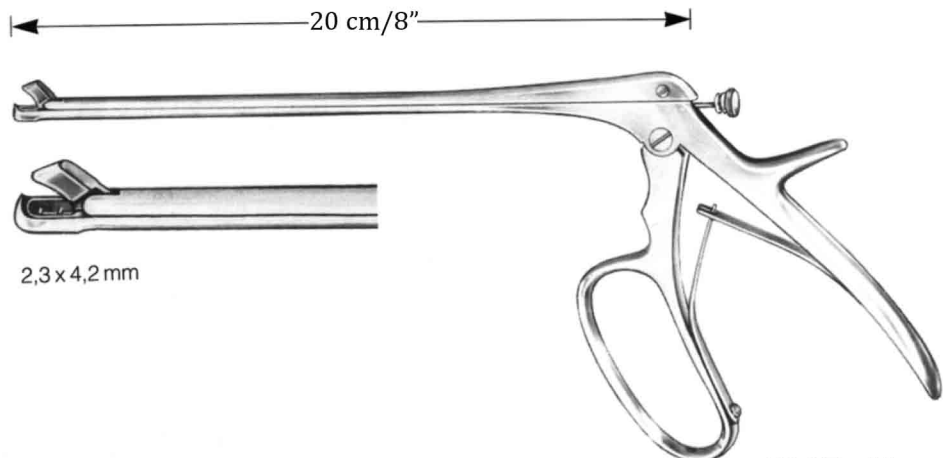

**Mini-Tischler
(Towensend- Mini)**
GI-6206-00

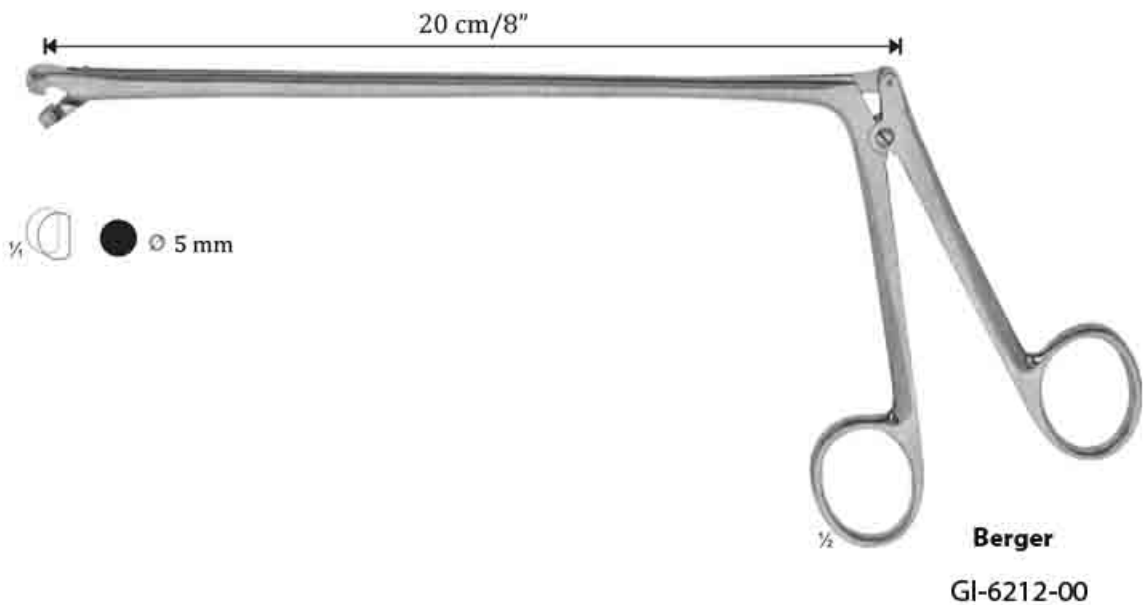
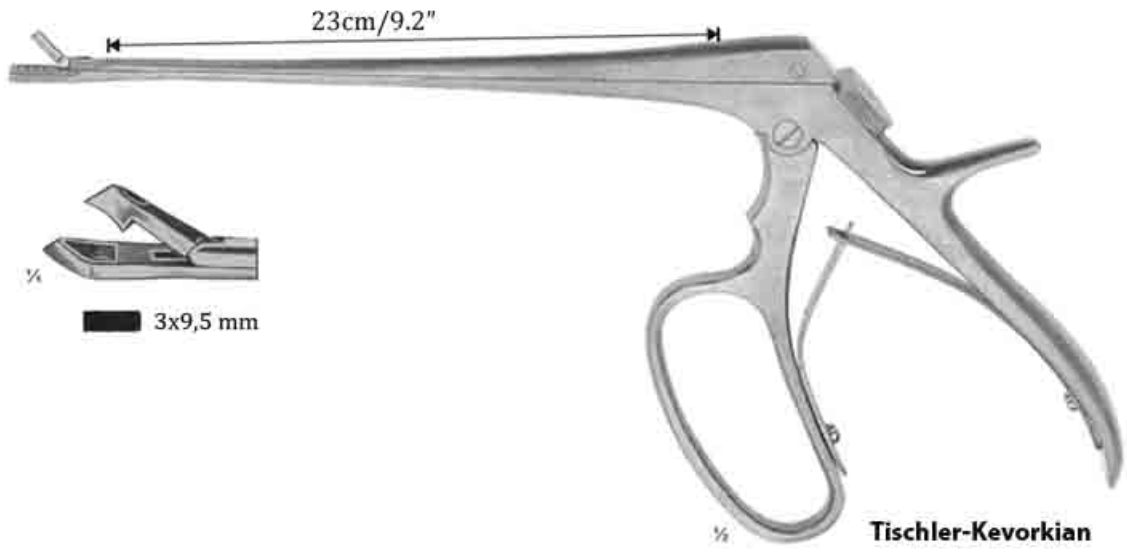

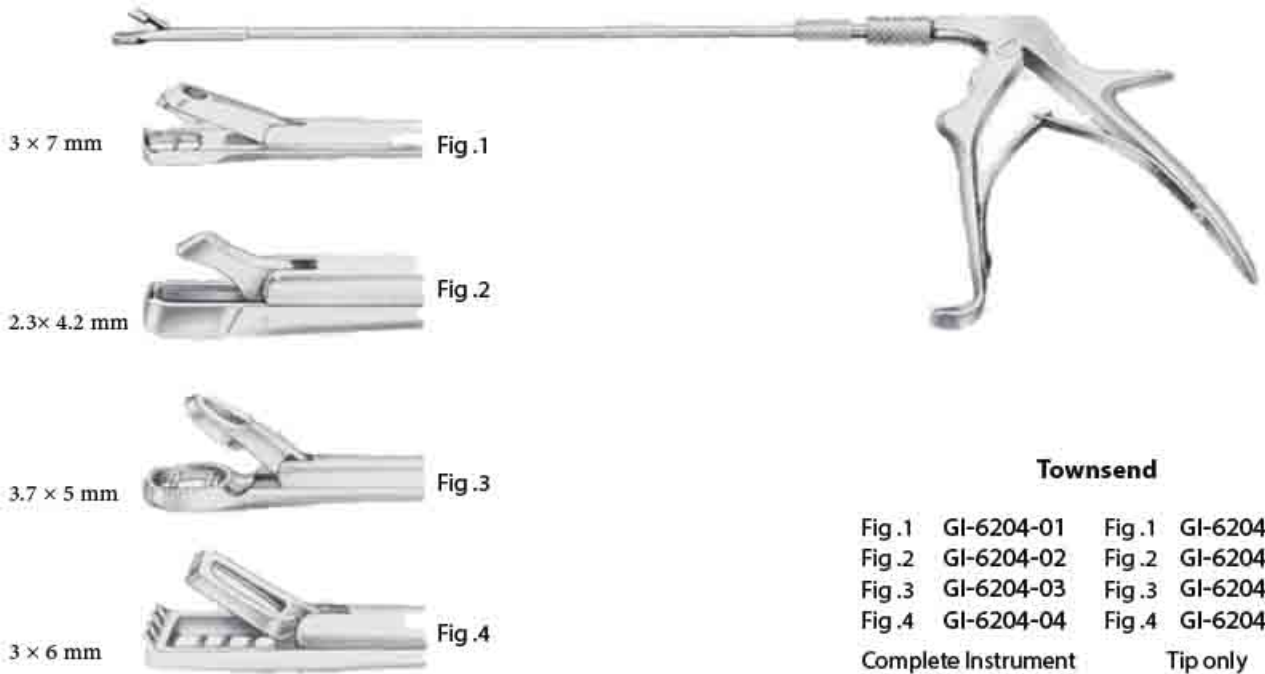

Townsend

Fig.1	GI-6204-01	Fig.1	GI-6204-11
Fig.2	GI-6204-02	Fig.2	GI-6204-12
Fig.3	GI-6204-03	Fig.3	GI-6204-13
Fig.4	GI-6204-04	Fig.4	GI-6204-14
Complete Instrument		Tip only	



Tischler-Morgan

Fig.1	GI-6302-01	Fig.1	GI-6302-11
Fig.2	GI-6302-02	Fig.2	GI-6302-12
Fig.3	GI-6302-03	Fig.3	GI-6302-13
Fig.4	GI-6302-04	Fig.4	GI-6302-14
Complete Instrument		Tip only	

Salpinograph

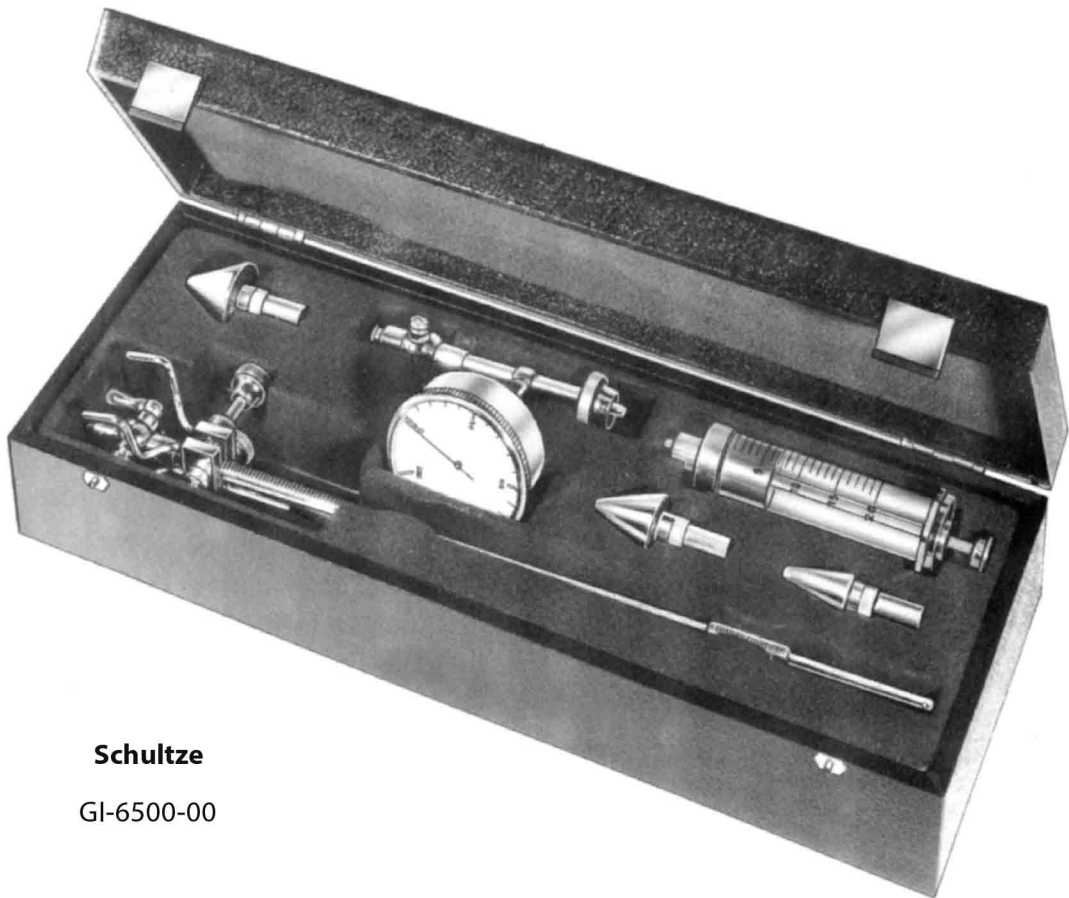

Schultze
GI-6500-00

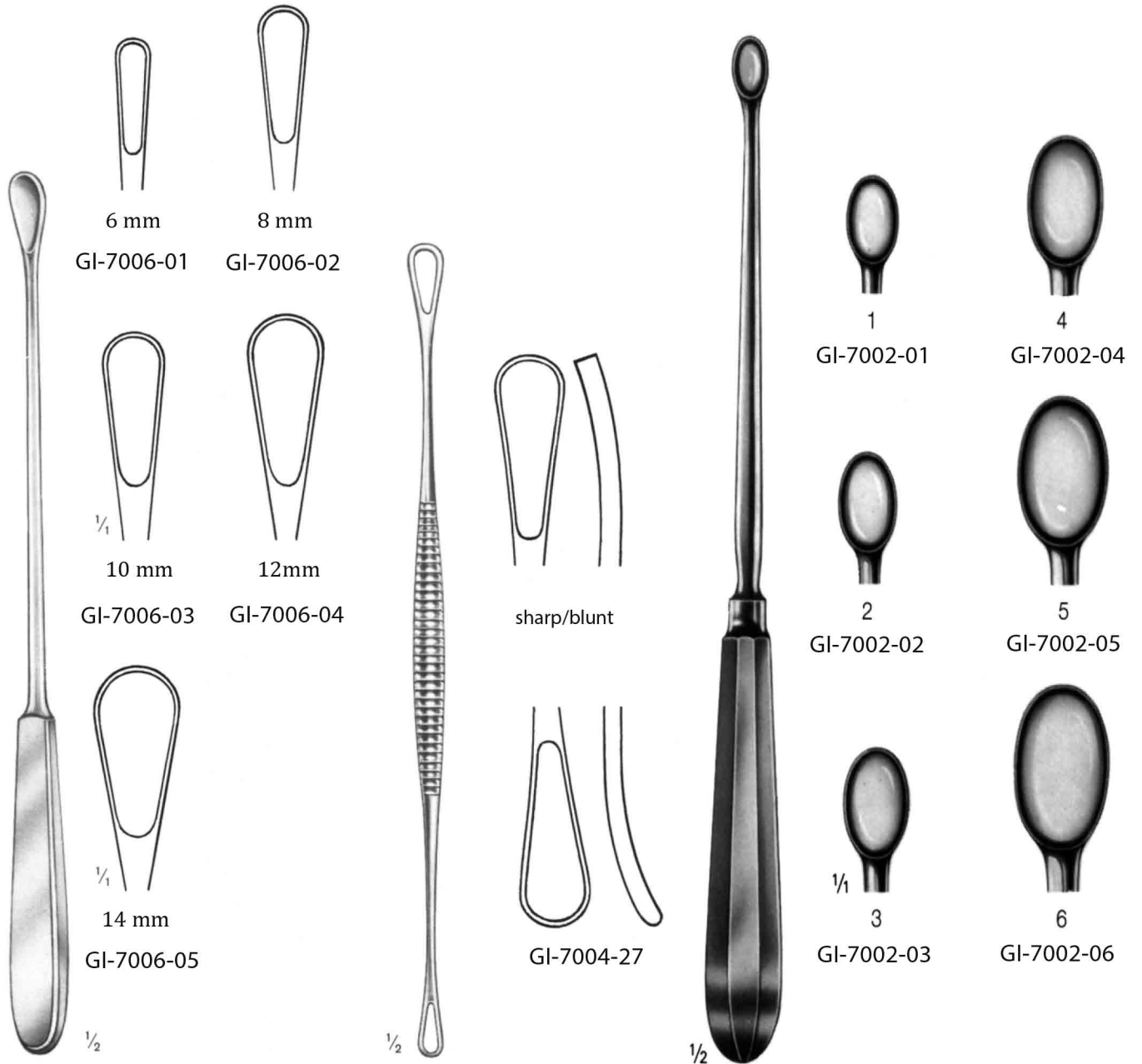

Gourdent

28cm/11"

Blake(Zweifel)

26 cm/10.4"

Simon

24cm/9.6"

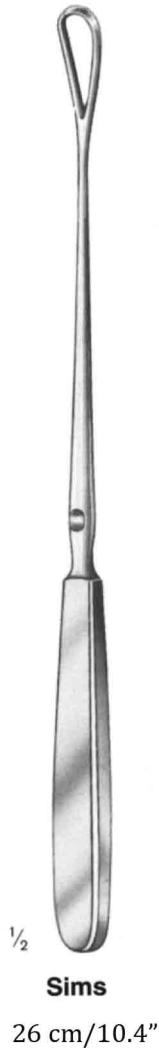

rigid	malleable	Fig.	rigid	malleable
GI-7100-05	GI-7105-05	00	GI-7102-05	GI-7107-05
GI-7100-06	GI-7105-06	0	GI-7102-06	GI-7107-06
GI-7100-07	GI-7105-07	1	GI-7102-07	GI-7107-07
GI-7100-08	GI-7105-08	2	GI-7102-08	GI-7107-08
GI-7100-09	GI-7105-09	3	GI-7102-09	GI-7107-09
GI-7100-11	GI-7105-11	4	GI-7102-11	GI-7107-11
GI-7100-12	GI-7105-12	5	GI-7102-12	GI-7107-12
GI-7100-14	GI-7105-14	6	GI-7102-14	GI-7107-14

sharp

blunt



Recamier

max.31 cm/12.4"

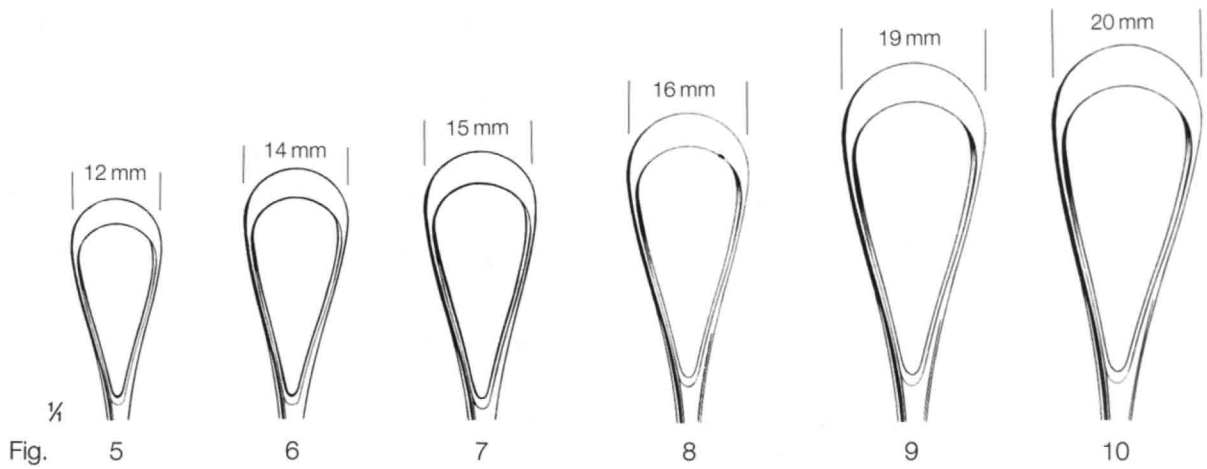
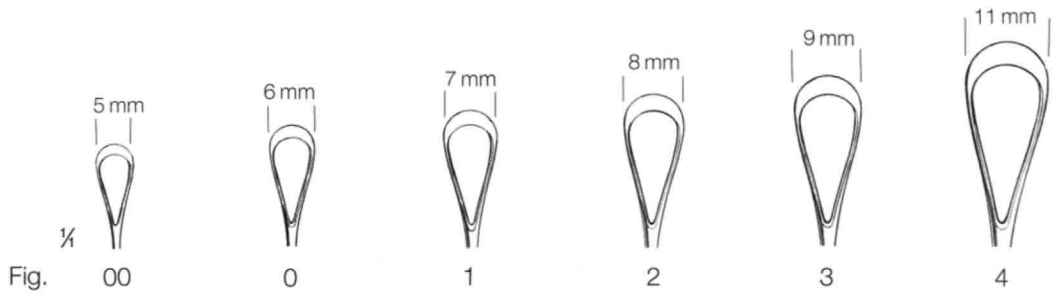

rigid

malleable

rigid

malleable

GI-7200-05
GI-7200-06
GI-7200-07
GI-7200-08
GI-7200-09
GI-7200-11
GI-7200-12
GI-7200-14
GI-7200-15
GI-7200-16
GI-7200-19
GI-7200-20

GI-7205-05
GI-7205-06
GI-7205-07
GI-7205-08
GI-7205-09
GI-7205-11
GI-7205-12
GI-7205-14
GI-7205-15
GI-7205-16
GI-7205-19
GI-7205-20

Fig.

00
0
1
2
3
4
5
6
7
8
9
10

GI-7202-05
GI-7202-06
GI-7202-07
GI-7202-08
GI-7202-09
GI-7202-11
GI-7202-12
GI-7202-14
GI-7202-15
GI-7202-16
GI-7202-19
GI-7202-20

GI-7207-05
GI-7207-06
GI-7207-07
GI-7207-08
GI-7207-09
GI-7207-11
GI-7207-12
GI-7207-14
GI-7207-15
GI-7207-16
GI-7207-19
GI-7207-20

sharp

blunt

Uterine Curettes

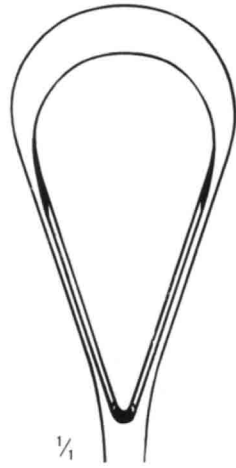

Fig. 14
30 mm



Fig. 15
35 mm

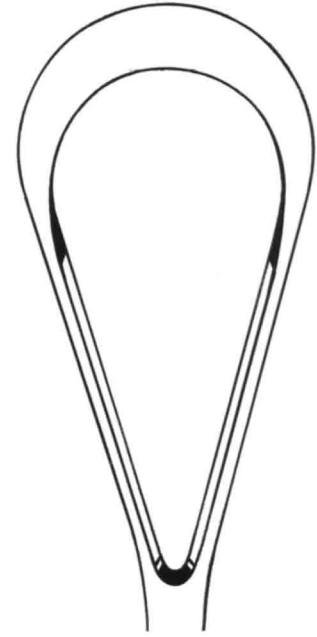

Fig. 16
40 mm

rigid	malleable	33 cm/13.6"	rigid	malleable
		Fig.		
GI-7300-30	GI-7305-30	14	GI-7302-30	GI-7307-30
GI-7300-35	GI-7305-35	15	GI-7302-35	GI-7307-35
GI-7300-40	GI-7305-40	16	GI-7302-40	GI-7307-40
sharp			blunt	

Recamier -Bumm



Thomas
28cm/11"
malleable



Fig.1
10 mm
GI-7401-01



Fig.4
14 mm
GI-7401-04



10 mm
GI-7403-10



Fig.2
12 mm
GI-7401-02



Fig.5
15 mm
GI-7401-05



12 mm
GI-7403-12



Fig.3
13 mm
GI-7401-03



Fig.6
16 mm
GI-7401-06



14 mm
GI-7403-14



Greene
28cm/11"
malleable

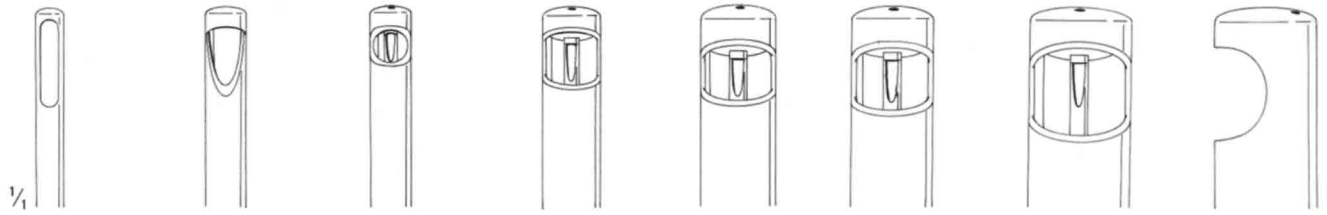

GI-7450-03 3 mm Ø GI-7450-04 4,5 mm Ø GI-7450-06 6 mm Ø GI-7450-08 8 mm Ø GI-7450-10 10 mm Ø GI-7450-12 12 mm Ø G-7450-14 14 mm Ø GI-7450-99

Specimen and Aspirating Currettes

Aspirating Currettes

Hose Connection